

Z-800 Infusion Pump

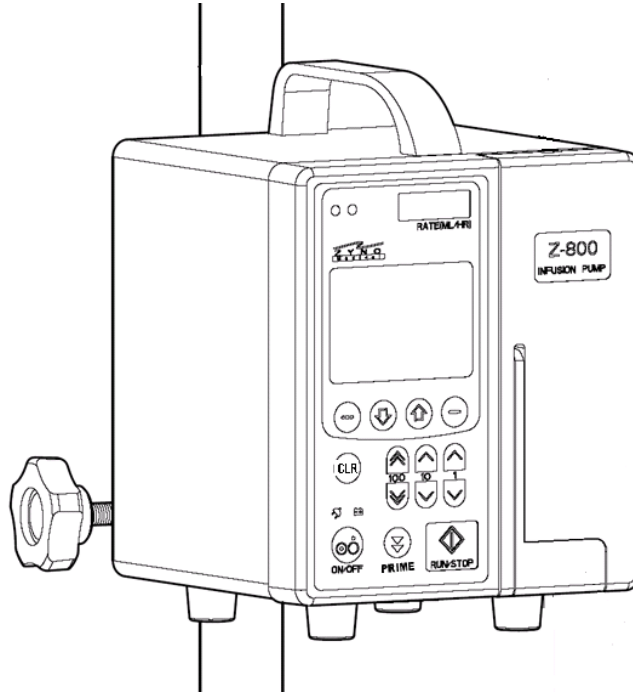

INSTRUCTIONS FOR USE

Revised 08/2010

Zyno Medical LLC

9 Tech Circle

Natick, MA, 01760

1-508-650-2008

Fax: 1-508-650-2006

Web: www.zynomedical.com

 **WARNING:**

Only use Zyno Medical provided IV sets with the Z-800 pump. There are risks associated with using any IV sets other than Zyno Medical sets with this device. Zyno's warranty for its device will be null and void and Zyno will assume no responsibility for any incidents that may occur if the device is not utilized strictly in accordance with its product labeling.

SAFETY STANDARD

The Z-800 infusion pump meets all safety standards for medical electrical devices, corresponding to IEC 60601-1 and IEC 60601-2-24.

TABLE OF CONTENTS

INTRODUCTION	
About the Device	4
Features	5
Symbols	6
GETTING STARTED	
Warnings & Cautions.....	7
Device Description	9
Installation Procedure	12
Preparing An Infusion	13
Loading Primary Administration Set	14
Continuous Mode Infusion	16
Time/VTBI Programming	24
Infusion Complete	26
10 STEP Mode Infusion	27
TPN Mode Infusion	29
Intermittent Mode.....	31
Blood Mode.....	34
Prime IV Set Using PRIME Key.....	36
Powering Off	39
Changing the Primary Solution Container	40
Changing & Reloading an IV Set During Infusion	41
Protocol Mode Infusion.....	42
Save Infusion Parameters as a Protocol	43
ALARMS AND TROUBLESHOOTING	
Definition	44
Alarms	45
Warnings	46
Errors	48
MAINTENANCE	
Specifications	48
Configurable Settings	50
Storage	55
Battery Care and Maintenance	56
Cleaning	59
Inspection Requirements.....	60
Service Information	61
Warranty.....	62
APPENDIX	
Alarm Testing Procedure	63
Approved Administration Sets	67

ABOUT THE DEVICE

The Z-800 Infusion pump is intended to provide accurate delivery of parenteral fluids, blood and blood products to a human patient when administered by a qualified health care professional.

User Qualification

The Z-800 infusion pump is intended for use at the direction or under the supervision of licensed physicians or certified healthcare professionals who are trained in the use of the Z-800 infusion pump and the administration of parenteral fluids and drugs, blood and blood products. This training should emphasize patient safety and prevention of error.

This document provides directions for use of the Z-800 infusion pump. To ensure safe usage, please read the entire instruction manual before using the device.

The Z-800 infusion pump must only be operated utilizing Zyno Medical's proprietary administration sets. The sets are designed for use with the Z-800 pump as well as for gravity-flow stand-alone use. For specific administration set instructions, refer to the Directions For Use provided with the set. For priming and loading instructions, refer to "Loading a Primary Administration Set" and "Loading a Secondary Administration Set" sections of this document.

Contraindication: None known.

FEATURES

Flow Rates	The Z-800 flow rate range is from 1 to 999 ml/h.
Free Flow Protection	<p>Z-800 Pump has a built in free flow clamp to prevent inadvertent free flow when the set is loaded in the pump.</p> <p> WARNING: Some Z-800 IV sets configurations do NOT have set based free-flow protection. Make sure to close roller clamp before removing administration set from Z-800 pump.</p>
Occlusion Pressure	The Z-800 Pump provides 14 levels adjustable downstream occlusion alarm thresholds between 4 psi to 30 psi.
Secondary Infusions	Secondary infusions may be delivered at a specified secondary delivery rate and secondary volume-to-be-infused (VTBI) independent of the primary infusion parameters. When secondary VTBI is greater than zero, the pump will always execute secondary infusion first. Automatic changeover occurs to the primary infusion parameters when the secondary infusion is complete. A Zyno Medical proprietary primary administration set with a back check valve must be used.
System Configuration	The system configuration mode provides the ability for qualified personnel to customize device settings.
Tamper Resist	The Tamper Resist feature provides a quick, one touch lockout of the front keypad.
Volume-To-Be-Infused (VTBI)	The volume-to-be-infused (VTBI) range is from 1 to 9999 ml in 1 ml increments.

SYMBOLS



Canadian and U.S. Certification Mark: Products bearing this mark have been tested and certified in accordance with applicable U.S. and Canadian electrical safety and performance standards (CSA C22.2 No. 601.1, UL 2601-1 and IEC 60601-2-24).



Electrical Shock Protection Rating: Type BF.

IPX1

Protection against fluid ingress: Drip Proof.



Attention: Refer to accompanying documentation.

Rx Only













Federal (U.S.A) law restricts this device to sale by or on the order of a physician.



Ground Pole. Potential Equalization Conductor (PEC). Note: If the integrity of the PEC or Hospital Earth System is in question, operate the instrument using internal battery power.













WARNINGS & CAUTIONS

The following Warnings and Cautions should be strictly followed to avoid harm to patients and pump operators:

-  **WARNING:** Zyno Medical assumes no responsibility for incidents that may occur if its product is not used in accordance with its product labeling.
-  **WARNING:** Only use Zyno Medical provided IV sets in the Z-800 pump.
-  **WARNING:** The Z-800 pump operation is strictly limited to trained operators whose competency in safe Z-800 pump operation and safe IV therapy practices has been tested and proven.
-  **WARNING:** Make sure the pump is stable by fastening securely to an IV pole, or resting on a flat surface. IV poles vary in quality and stability. Avoid fastening the pump too high on the pole, and test for stability before using.
-  **WARNING:** Prior to use, always verify the proper function of the display, audible and visual alarms.
-  **WARNING:** Verify there are no kinks in the tubing when loading into the pump.
-  **WARNING:** Always read and follow the instructions that accompany the fluid container and IV administration sets you are using. Carefully follow the instructions in this document for loading, removing, and reloading the IV set. Adjust the pumping section of the IV set every 24 hours, and replace the IV set at least every 72 hours.
-  **WARNING:** To prevent free flow, make sure to load the IV set in the pump before connecting the IV set to patient.
-  **WARNING:** To prevent free flow, make sure to disconnect the IV set from patient before unloading the IV set from the Z-800 pump.
-  **WARNING:** Disconnect IV set from the patient before purging air bubbles out of IV tubing.
-  **WARNING:** Some Z-800 IV sets configurations do NOT have set based free-flow protection. Make sure to close roller clamp before removing administration set from Z-800 pump.
-  **WARNING:** Do not over-program VTBI. Program the actual amount of the fluid in the IV bag.

GETTING STARTED

WARNINGS & CAUTIONS (Continued)

-  **WARNING:** After starting an infusion, make sure drops are falling in the drip chamber. If no drops are falling, make sure the roller clamp is open. If the roller clamp is open and still no drops are falling, replace and dispose of the IV administration set.
-  **WARNING:** The air detector cannot recognize the introduction of air at 3-way stopcocks, infusion ports, and other lines/tubes below the pump.
-  **WARNING:** Do not operate this device in the presence of flammable anesthetics mixture with air or oxygen or nitrous oxide.
-  **WARNING:** Do not expose Z-800 pump to X-Rays, gamma rays or other radiation, or to strong electric or magnetic fields.
-  **WARNING:** The factory default settings should be used unless qualified clinical personnel determine that other customized settings are appropriate and safe.
-  **CAUTION:** Please read the entire contents of this manual before using the Z-800 pump.
-  **CAUTION:** USA Federal and Canadian laws restrict this device to sale by or on the order of a physician.
-  **CAUTION:** No user serviceable parts inside. Refer all service, repair, and calibration to qualified technical personnel. Do not make unauthorized modifications.
-  **CAUTION:** To avoid mechanical or electronic damage, do not steam, autoclave or immerse the pump in any fluids or cleaning solutions, and do not spray such fluids directly on the pump. Always disconnect electrical power cord from outlet before cleaning to prevent electrical shock. The IPX1 rating means that the pump is protected against vertical dripping water.
-  **CAUTION:** Do not attempt to infuse two fluids simultaneously using the Z-800 infusion pump.
-  **CAUTION:** Operating Z-800 infusion pump near equipment that radiates high-energy radio frequencies (electrosurgical/cauterizing equipment, portable radios, cellular telephones, etc.) may cause false alarm conditions. If this happens, reposition the device away from the source of interference or use an appropriate clinical alternative.
-  **CAUTION:** Always verify displayed infusion parameters (Primary Rate, Primary VTBI, Secondary Rate, Secondary VTBI) against prescription before starting infusion.

GETTING STARTED

DEVICE DESCRIPTION

Pump Front View – Door Closed

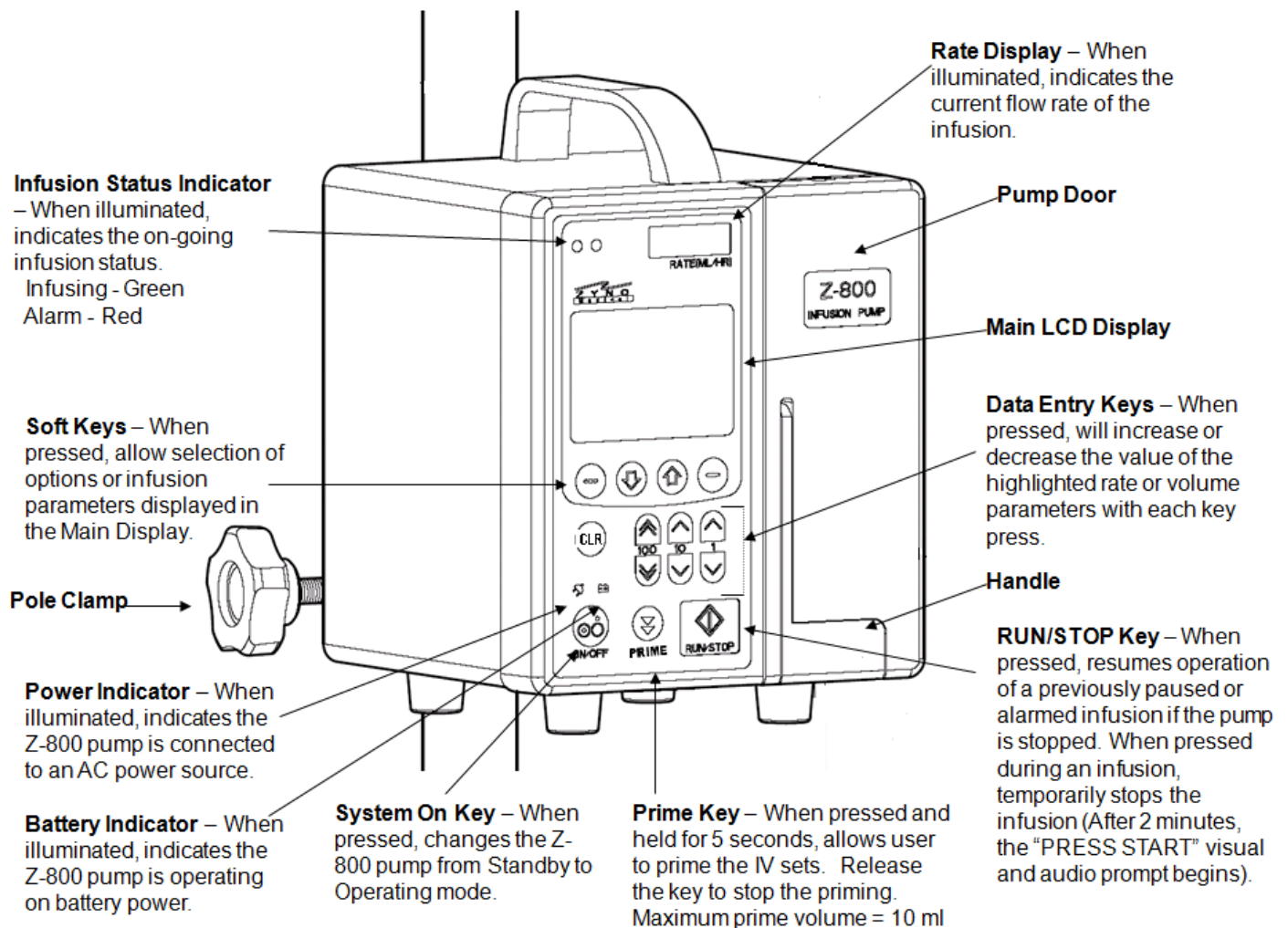

GETTING STARTED

DEVICE DESCRIPTION (Continued)

Pump Front View - Door Open

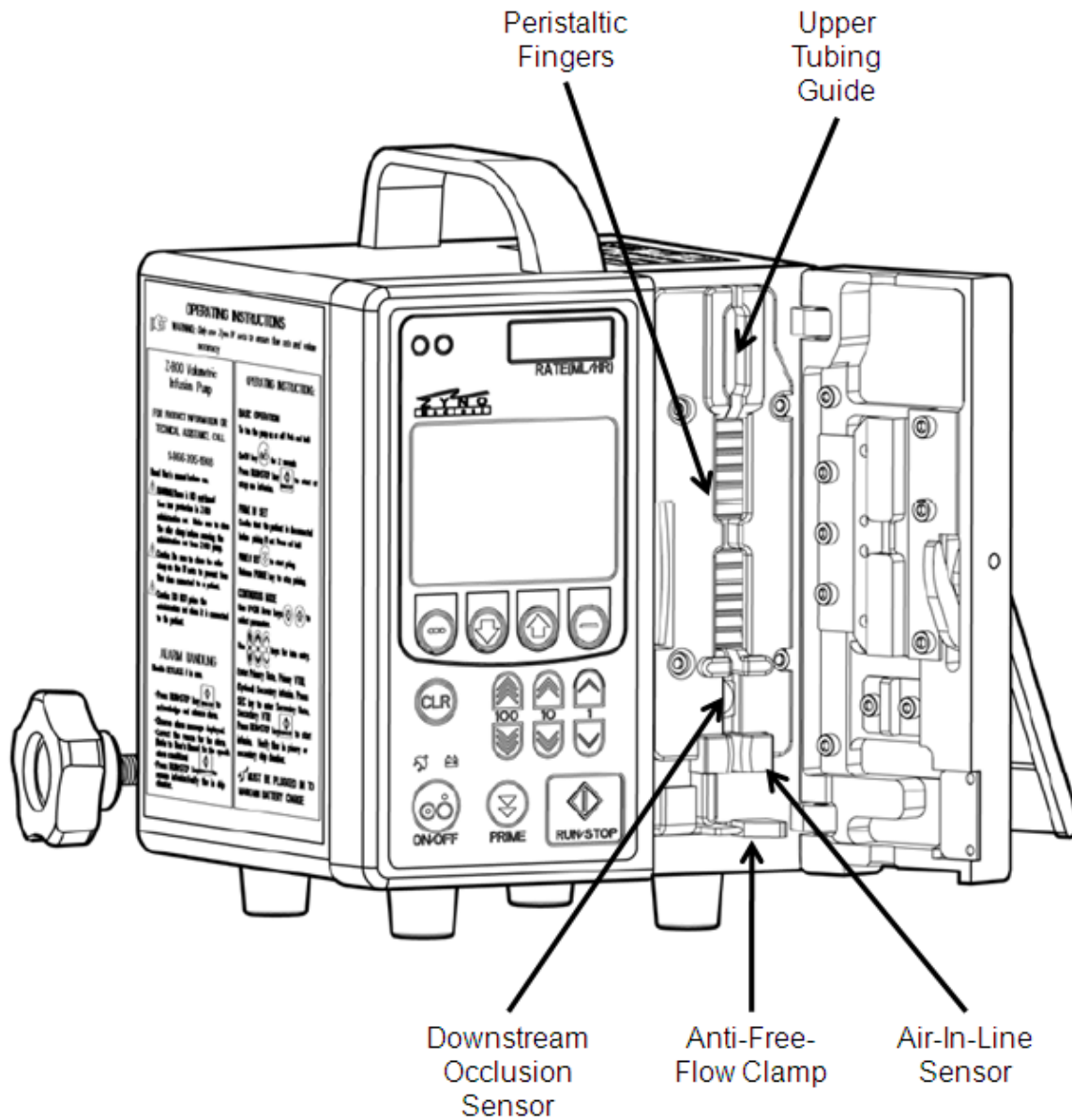

GETTING STARTED

DEVICE DESCRIPTION (Continued)

Pump Back View

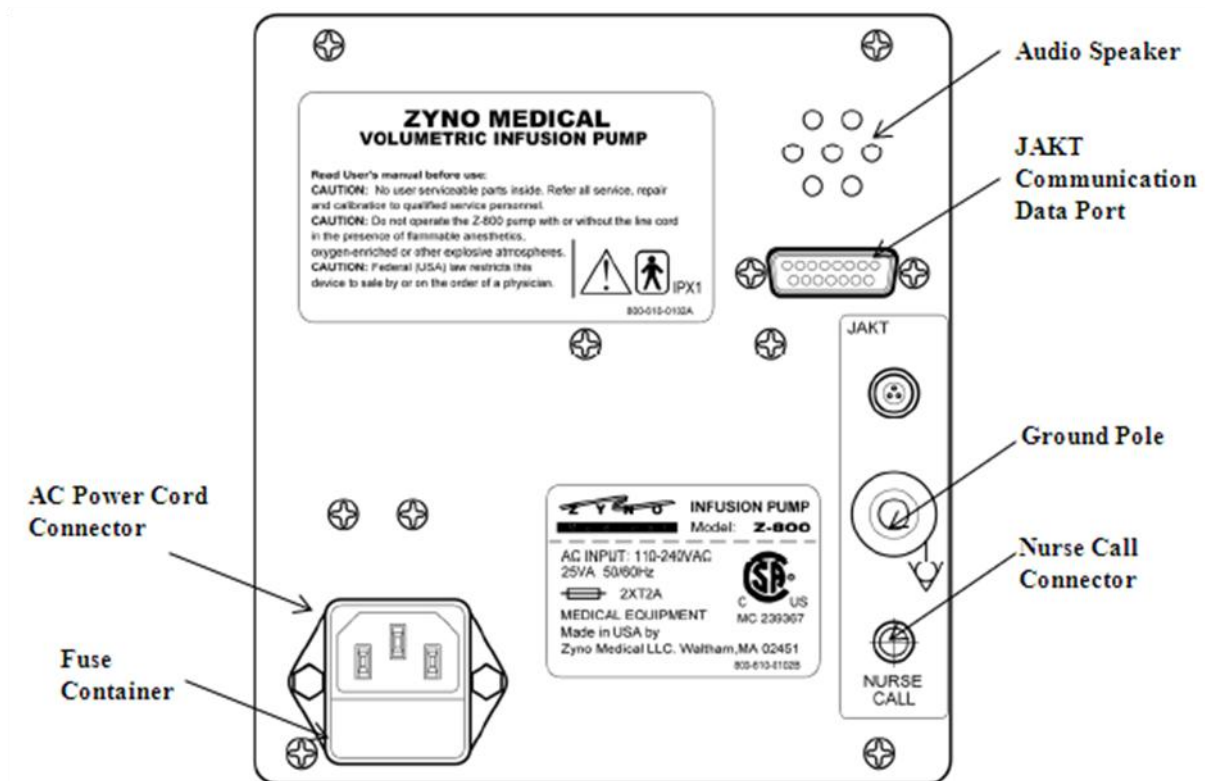

GETTING STARTED

INSTALLATION PROCEDURE

UNPACK THE PUMP

The Z-800 infusion pump is supplied complete with

- A standard detachable, listed/certified IEC Hospital Grade electrical cord.
- Pole Clamp pre-mounted at 45 degree angle to the pump.
- Instruction for Use.

1. Remove Pump module from its carton.
2. Inspect the pump.
3. Check to ensure pump door operates freely.
4. Check for any loose parts.

NOTE: If any of the following conditions are observed, the Z-800 pump must be removed from use and inspected by qualified personnel:

- Look for any signs of physical damage from shipping.
- LED segments are not illuminated during system power-on self-test.
- Indicator lights do not illuminate.
- Audio tune does not sound.
- Main Display does not appear backlit, appears irregular, or has evidence of a row of pixels not functioning properly.

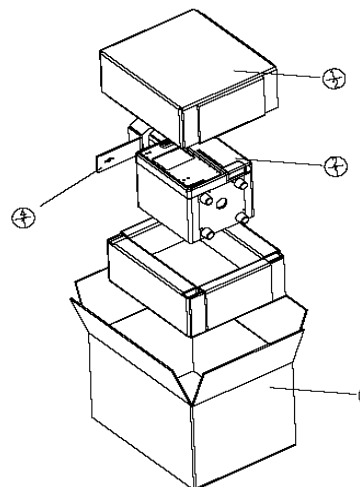

MOUNT PUMP TO IV POLE

1. Attach the pump to an IV pole by turning the knob on the pole clamp clockwise, or place the pump on a flat, stable surface.

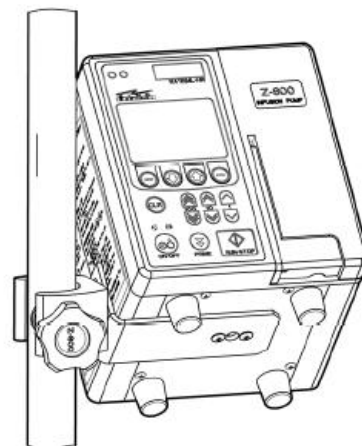

PREPARING AN INFUSION

Powering On the System

1. Connect the Z-800 Pump power cord to an AC power source.
2. Press and hold the **ON/OFF** key on the Z-800 Pump for 2 seconds.
3. System self-test begins:
 - The diagnostics test causes all LED display segments and Status indicator lights to illuminate briefly.
 - The Power Indicator illuminates.
 - An Audio tune sounds.
4. The Main Display shows the Zyno Medical Logo, Pump Serial Number and Software Version for 2 seconds and pump safety configurations for 2 seconds during the system power-on self-test.
5. Upon completion of system power-on self-test, A New Infusion prompt screen will be displayed prompting user to choose either resume a previously interrupted infusion or start with a new infusion.
6. If the user elects to resume the previously interrupted infusion, the pump will enter into the Programming screen of the previous selected infusion mode and with the previous infusion parameters populated.
7. If the user elects to start a new infusion, the pump will prompt user to select the Infusion Mode. Upon user selection, the pump will enter into the Infusion Programming screen of the selected Infusion Mode with all infusion parameters reset to zero. The user may choose one of the following infusion modes:
 - Continuous Mode with Rate/VTBI parameters
 - Continuous Mode with Time/VTBI parameters
 - 10 Step Mode
 - TPN Auto Ramp Mode
 - Stored User-Defined Protocols

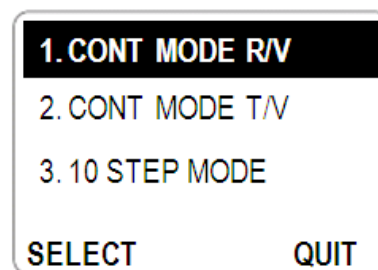
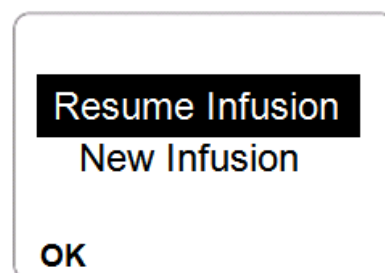

GETTING STARTED

LOADING PRIMARY ADMINISTRATION SET

Preparing the Primary Solution Container

Prepare the primary solution container in accordance with the manufacturer's directions for use.

Preparing the Primary Administration Set

Use only Zyno administration sets (refer to **Approved Administration Sets** section for a list of compatible sets). Open the administration set package, remove the set and close the roller clamp.

⚠ WARNING: Some Z-800 IV sets configurations do NOT have set based free-flow protection feature. Make sure to close roller clamp before removing administration set from Z-800 pump.

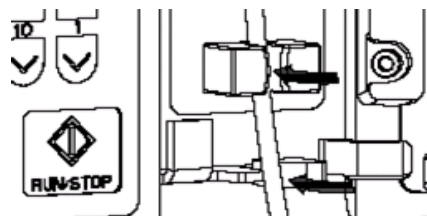

Steps 6 & 7

Loading Primary Administration Set

1. Insert set spike into prepared fluid container following accepted clinical procedure, and hang the container approximately 20 inches above the Pump.
2. Fill the drip chamber to 1/3 full by squeezing it.
3. Open the roller clamp slowly, to prime tubing and clear air from the luer lock at the patient (distal) end of the administration set.
4. Close the roller clamp.
5. Open the pump door.
6. Using a fingertip, firmly push tubing into the gap of Air-in-Line Sensor. (See picture "Steps 6 & 7")
7. Align tubing on top of the gap of Free Flow Clamp (Do not force tubing into the Free Flow Clamp). The pump will load the tubing into the Free Flow Clamp automatically when the pump door is closed.
8. Using a fingertip, firmly push tubing into the gap of the tubing guides on the pumping fingers. (See picture "Step 8")
9. Using a fingertip, firmly push tubing into the gap of upper tubing guides. (See picture "Step 9")
10. Close pump door by pushing down the pump door handle (See picture "Step 10")
11. Connect the administration set to the patient's injection site.

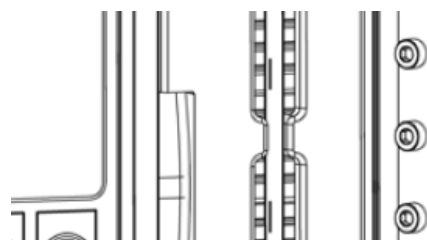

Step 8

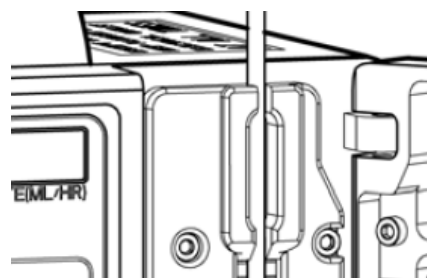

Step 9

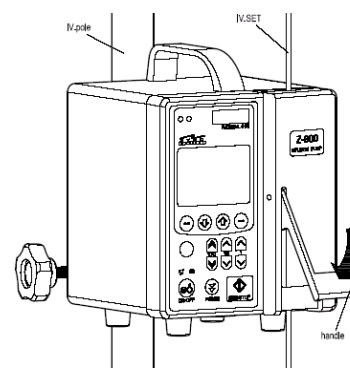

Step 10

LOADING PRIMARY ADMINISTRATION SET (Continued)

LOADING IV SET INTO Z-800 PUMP

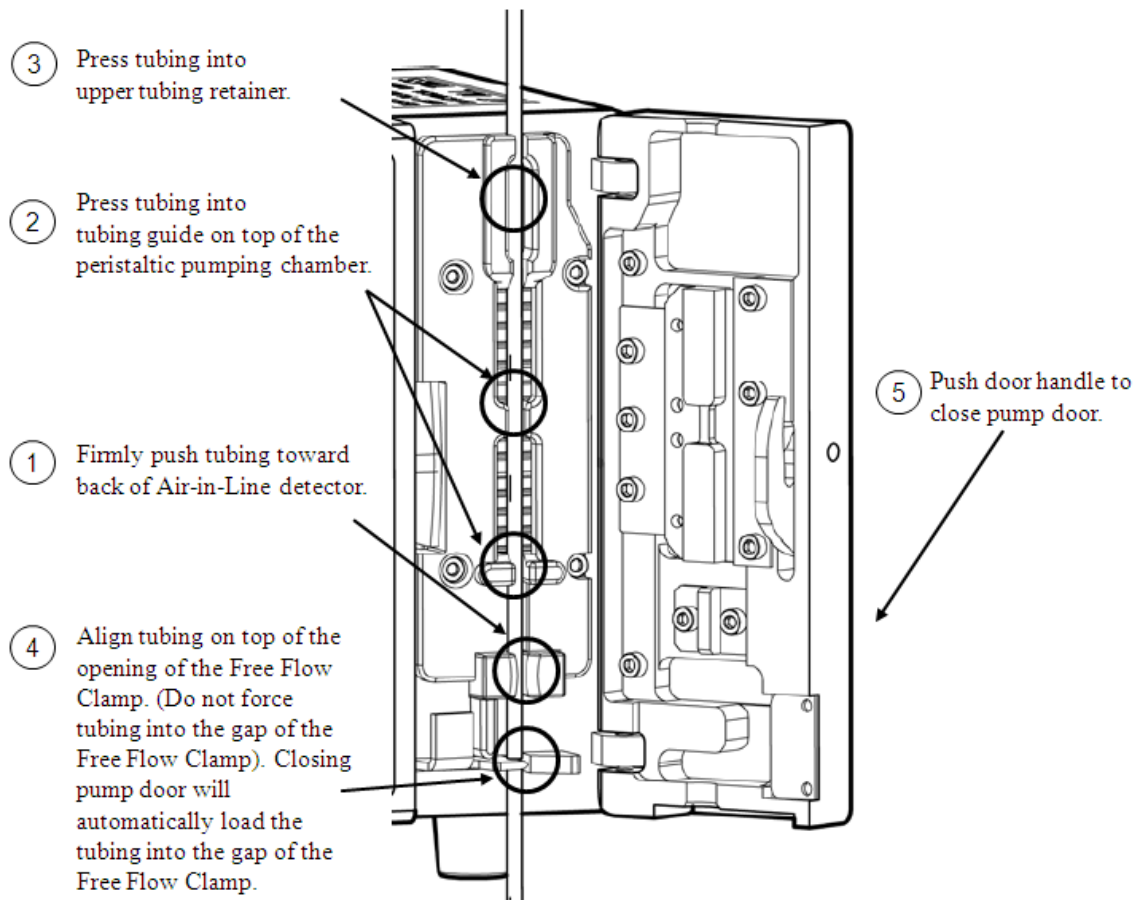

⚠ WARNING: Some Z-800 IV sets configurations do NOT have set based free-flow protection feature. Make sure to close roller clamp before removing administration set from Z-800 pump.

GETTING STARTED

CONTINUOUS MODE—PRIMARY INFUSION

Primary Infusion Programming Screen

User may choose to program the continuous infusion either in RATE/VTBI or TIME/VTBI. The primary infusion programming screen contains the following display areas:



1. **Status Bar:** The Status Bar displays current operating mode; current pump state; and volume infused.
 - **CONT:** Indicate the current application mode is Continuous Mode Operation.
 - **SET:** Indicate the current pump state is Programming state.
 - **VINF:** Volume Infused during the current infusion.
2. **Infusion Parameters:** -- Primary Flow Rate and Primary Volume To Be Infused.
 - **Pri RATE:** Primary Flow Rate.
 - **Pri VTBI:** Primary VTBI.
3. **Soft Keys:** Allows user to access pump configuration and secondary infusion programming screen.
 - **CONFIG:** Access configurable settings.
 - **SEC:** Access secondary infusion programming.
 - **Up/Down Arrows:** Select parameter items.

 **WARNING:** Do not over-program VTBI. Program the actual amount of IV bag fluid.

Change Primary Flow Rate

Use Up/Down Arrow keys to highlight Pri RATE. Use Data Entry keys to modify the corresponding digits of Pri RATE value.

Example: Programming Pri RATE = 125 mL/h

1. Use Up/Down Arrow keys to highlight Pri RATE.
2. Press the 100's Up data entry key  once to increase the 100's digit of Pri RATE to 100.
3. Press the 10's Up data entry key  twice to increase the 10's digit of Pri RATE to 20.
4. Press the single digit's Up data entry key  five times to increase the single digit of Pri RATE to 5.

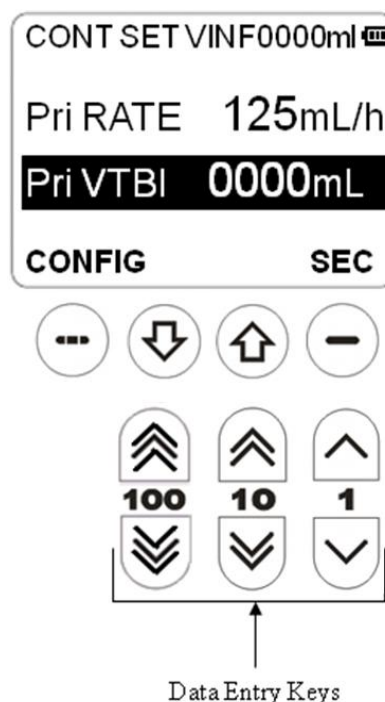
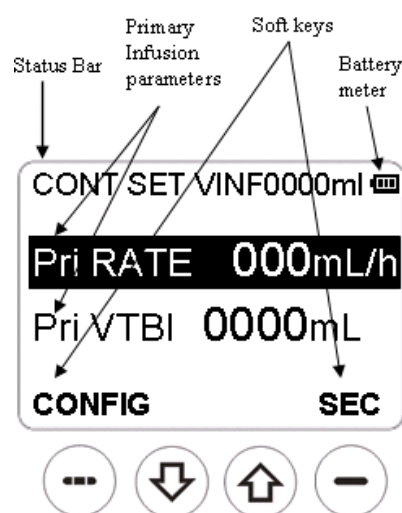

GETTING STARTED

CONTINUOUS MODE—PRIMARY INFUSION (Continued)

Change Primary VTBI

Use Up/Down Arrow keys to highlight Pri VTBI. Use Data Entry keys to modify the corresponding digits of Pri VTBI value.

Example: Programming Pri VTBI = 250 ml
Use Up/Down Arrow keys to highlight Pri VTBI.

Press the 100's Up data entry key  twice to increase the 100's digit of Pri VTBI to 200.

Press the 10's Up data entry key  five times to increase the 10's digit of Pri VTBI to 50.

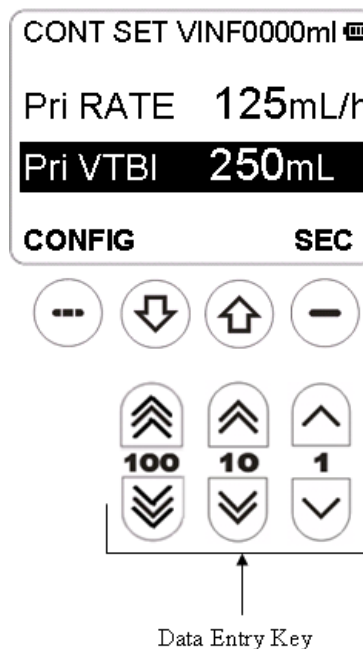

Start Primary Infusion

Verify displayed infusion parameter entries (Primary Rate, Primary VTBI). If a clamp is engaged, remove the clamp. Press **RUN/STOP** key to start the infusion.

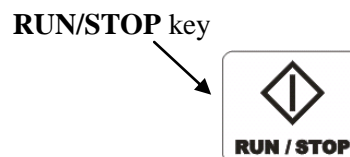

Stopping and Resuming a Primary Infusion

Press **RUN/STOP** key during infusion. The infusion will be paused. The **PAUSE** screen will be displayed.

From the **PAUSE** state, press **RUN/STOP** key to resume infusion.

Titrate Flow Rate or VTBI During a Primary Infusion

From the **PAUSE** screen, press **PROG** soft key; the pump will display primary infusion programming screen. User is then able to modify the primary RATE and primary VTBI parameters.

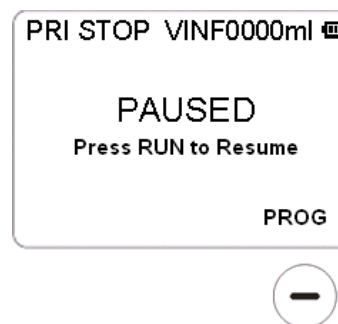

GETTING STARTED

CONTINUOUS MODE--PRIMARY INFUSION (Continued)

Primary Infusion Execution

- During an infusion, the two Infusion Status Indicator LEDs will illuminate in green and toggle once per second.
- The primary infusion execution display contains the following contents:

Status Bar: The Status Bar displays the current operating mode; current pump state; and volume infused.

- **CONT:** Continuous Mode Operation.
- **RUN:** Pump RUN state.
- **TL:** Time Left in HH:MM format for the current infusion.

Infusion Parameters: Current infusion parameters.

- Pri RATE field displays primary flow rate.
 - Pri VTBI field counts down to show remaining VTBI.
 - Pri VINF field counts up to show volume infused.
- 3 minutes before infusion completes, a short audio prompt tone will sound twice. Along with the audio prompt, the screen will display “INFUSION NEAR END” message. This alert will repeat every 5 seconds until the infusion is complete.
 - At completion of the infusion, an audio prompt sounds. Along with the audio prompt, the screen will display “INFUSION COMPLETE – KVO”. This alert will repeat every 5 seconds until user intervention. During KVO state, the Flow Rate Indicator will change to display KVO flow rate.

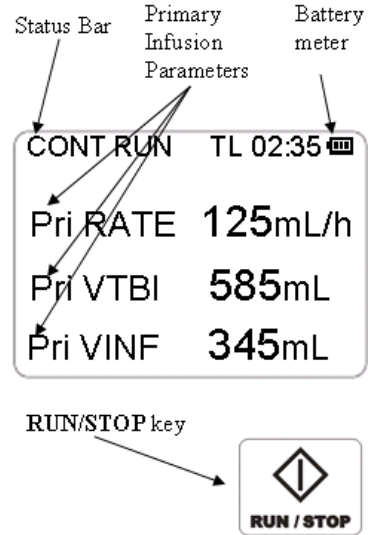

Clearing the Volume Infused During a Primary Infusion:

Pause the primary infusion by pressing the **RUN/STOP** key during infusion. Exit the PAUSE screen by pressing the **PROG** soft key. From the **Primary SETUP** screen, press the **CLR** soft key. An audio/visual prompt will be presented requesting user confirmation of clearing VINF. Press the **OK** soft key to confirm. The VINF field will be reset to 0 ml. A confirmation screen will be displayed briefly indicating VINF has been cleared. From the “Clear VINF?” screen, user can press the **QUIT** soft key to abort the action.

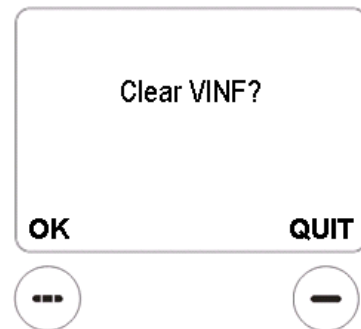

NOTE: The VINF field will record cumulative infusion volume infused unless cleared by pressing the **CLR** soft key or turning the pump off/on and starting a new infusion.

GETTING STARTED

LOADING A SECONDARY ADMINISTRATION SET

1. Program and start the primary infusion using a check-valve primary administration set, as previously described.
2. Open a secondary administration set package, remove the set and close the set roller clamp.
3. Insert set spike into a prepared fluid container and hang secondary container, following accepted clinical procedures.
4. Fill the drip chamber to 1/3 full.
5. Open a secondary set and prime the set. Close the set roller clamp.
6. Attach a secondary set to the upper injection site on the primary set.
7. Ensure no air bubbles are present in the line.
8. Hang the secondary fluid container at least 8 inches above the primary solution container.

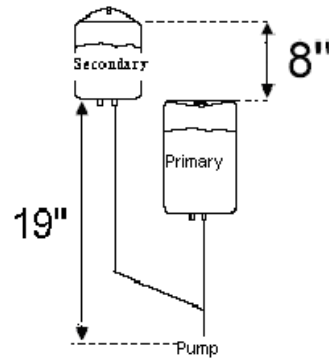

⚠ WARNING: Some Z-800 IV sets configurations do NOT have set based free-flow protection. Make sure to close roller clamp before removing administration set from Z-800 pump.

⚠ WARNING: The bottom of the secondary solution should be at least 19" above the top of the pump.

⚠ WARNING: A minimum height differential between primary and secondary solutions of eight inches is essential for the safe operation of a primary/secondary infusion.

GETTING STARTED

CONTINUOUS MODE--SECONDARY INFUSION

Access Secondary Infusion Programming Screen

From the Continuous Mode Primary Infusion Programming screen, Press SEC soft key to access the secondary infusion programming screen.

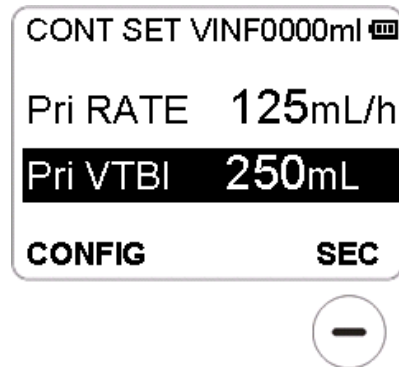

Secondary Infusion Programming Screen

Similar to the primary infusion programming screen, The secondary infusion programming screen contains the following display areas:

1. **Status Bar:** The Status Bar displays current operating mode; current pump state; and volume infused.
 - **CONT:** Continuous Mode Operation.
 - **SET:** Setup pump state.
 - **VINF:** Volume Infused for the current infusion.
2. **Infusion Parameters:** Secondary Flow Rate and Secondary Volume To Be Infused.
 - **Sec RATE:** Secondary Flow Rate.
 - **Sec VTBI:** Secondary VTBI.
3. **Soft Keys:** Allow user to access pump configuration and primary infusion programming screen.
 - **CONFIG:** Access pump configuration.
 - **PRI:** Access primary infusion programming.
 - **Up/Down Arrows:** Select parameter items.

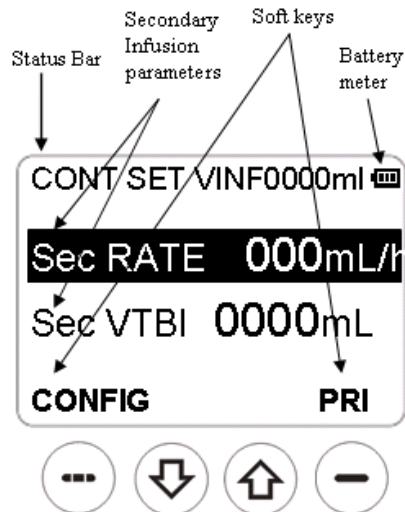



GETTING STARTED

CONTINUOUS MODE--SECONDARY INFUSION (Cont.)

Change Secondary Flow Rate

Use Up/Down Arrow keys to highlight Sec RATE. Use Data Entry keys to modify the corresponding digits of Sec RATE value.

Example: Programming Sec RATE = 275 mL/h

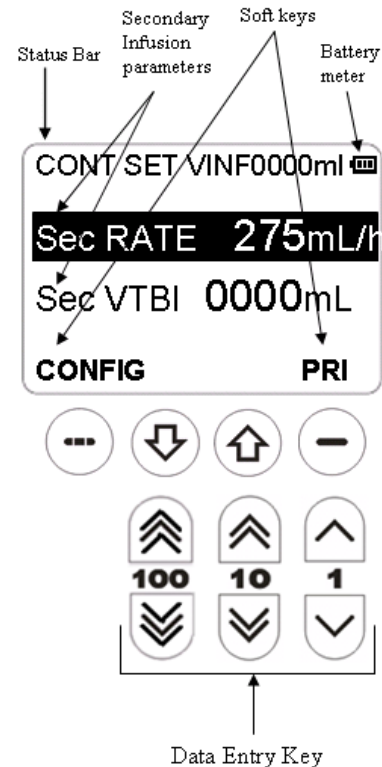

1. Use Up/Down Arrow keys to highlight Sec RATE.
2. Press the 100's Up data entry key  twice to increase the 100th digit of Sec RATE to 200.
3. Press the 10's Up data entry key  seven times to increase the 10th digit of Sec RATE to 70.
4. Press the single digit's Up data entry key  five times to increase the single digit of Sec RATE to 5.



Change Secondary VTBI

Use Up/Down Arrow keys to highlight Sec VTBI. Use Data Entry keys to modify the corresponding digits of Sec VTBI value.

Example: Programming Sec VTBI = 150 mL

1. Use Up/Down Arrow keys to highlight Sec VTBI.
2. Press the 100's Up data entry key  once to increase the 100th digit of Sec VTBI to 100.
3. Press 10's Up data entry key  five times to increase the 10th digit of Sec VTBI to 50.



GETTING STARTED

CONTINUOUS MODE--SECONDARY INFUSION (Cont.)

Start Secondary Infusion

Verify displayed infusion parameter entries (Primary Rate, Primary VTBI, Secondary Rate, Secondary VTBI). If a clamp is engaged, remove the clamp. Press **RUN/STOP** key to start the infusion.

NOTE: Secondary infusion will be executed before primary infusion.

Secondary Infusion Execution

- The two Infusion Status Indicator LEDs will illuminate in green and toggle once per second.
- The secondary infusion execution display contains the following contents:

Status Bar: The Status Bar displays current operating mode; current pump state; and volume infused.

- **CONT:** Continuous Mode Operation.
- **RUN:** Pump RUN state.
- **TL:** Time Left in hours: minutes (HH:MM) format for the current infusion.

Infusion Parameters: Current infusion parameters

- **SEC RATE** field displays secondary flow rate.
 - **SEC VTBI** field counts down to show remaining VTBI.
 - **SEC VINF** field counts up to show volume infused.
- Upon completion of secondary infusion, a switchover audio alert sounds 2 short beeps. The Main Display will switch-over to **PRI RATE**, **PRI VTBI** and **PRI VINF**.

RUN/STOP key

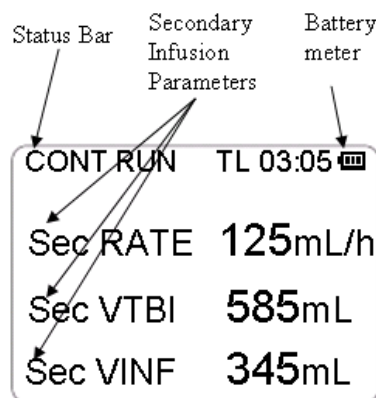

RUN/STOP key



WARNING: Do not over-program VTBI. Program the actual amount of the fluid in the IV bag.

GETTING STARTED

CONTINUOUS MODE--SECONDARY INFUSION (Cont.)

Stopping and Resuming a Secondary Infusion

Press **RUN/STOP** key during infusion. The infusion will be paused. The **PAUSE** screen will be displayed.

From **PAUSE** state, press **RUN/STOP** key to resume infusion.

Changing Rate or VTBI During a Secondary Infusion

From the **PAUSE** screen, press **PROG** soft key; the Z-800 pump will enter secondary infusion programming screen. User is able to modify the secondary **RATE** and secondary **VTBI** parameters.

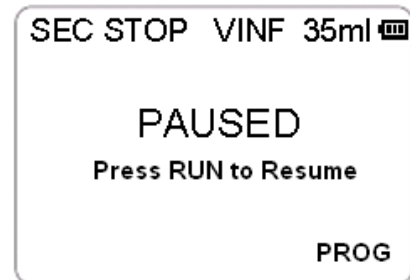

GETTING STARTED

TIME/VTBI Programming

Access TIME/VTBI Programming Option

The Z-800 pump provides TIME/VOLUME programming options for Continuous Mode Infusion. The user may choose the infusion programming parameter option in the pump configuration screen.

1. Press the **CONFIG** soft-key to access pump configuration menu from Infusion Programming screens
2. In Pump Configuration, use Up/Down Arrow keys to highlight **2. CONT MODE T/V** and press the **SELECT** soft-key.
3. The display will switch to continuous mode primary infusion programming screen with TIME and VTBI parameters.

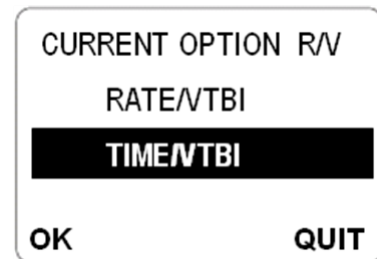
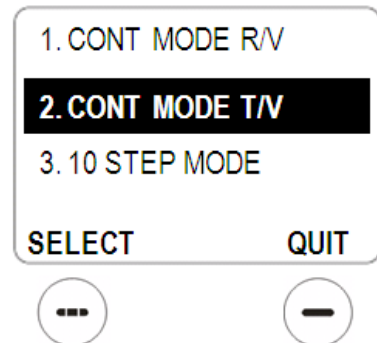

GETTING STARTED

TIME/VOLUME Programming (Continued)

Programming in TIME/VTBI Option

Upon selection of the TIME/VTBI programming option, the continuous mode infusion programming screen will present Total Infusion Time and Total VTBI parameters. The TIME/VTBI infusion programming screen contains the following display areas:

1. **Status Bar:** The Status Bar displays current operating mode; current pump state; and volume infused.
 - **CONT:** Continuous Mode Operation
 - **SET:** Programming pump state.
 - **VINF:** Volume Infused for the current infusion.
2. **Infusion Parameters:** -- Primary Infusion Time and Primary Volume To Be Infused.
 - **Pri TIME:** Primary Infusion Time.
 - **Pri VTBI:** Primary VTBI.
3. **Soft Keys:** Allows user to access pump configuration and secondary infusion programming screen.
 - **CONFIG:** Access pump configuration.
 - **SEC:** Access secondary infusion programming screen. The Secondary Infusion Parameters will be presented as Sec TIME and Sec VTBI
 - **Up/Down Arrows:** Select parameter items. Similar to the RATE/VTBI programming screen, The TIME/VTBI infusion parameters may be programmed by using the UP/DOWN Arrow keys and Data Entry keys.

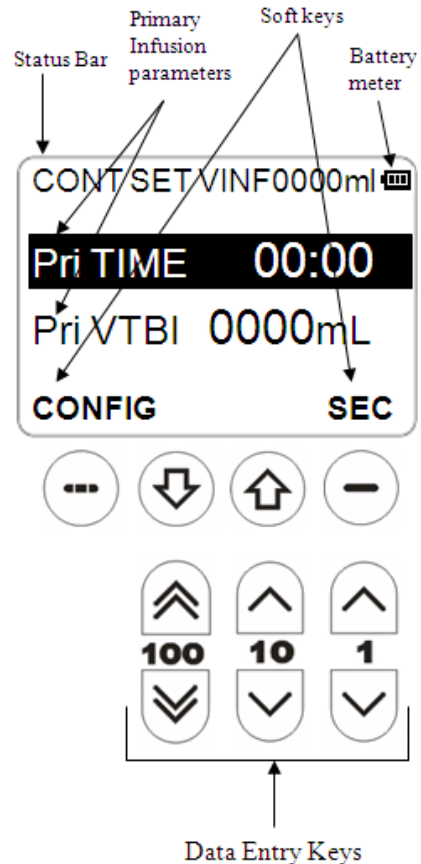

⚠ WARNING: Do not over-program VTBI. Program the actual amount of the fluid in the IV bag.

INFUSION COMPLETE

When the VTBI parameter of the current infusion decreases to zero, the pump determines that the infusion is completed and the pump automatically switches over to KVO mode.

The Main display will present the “INFUSION COMPLETE – KVO” message and the KVO flow rate. An audio warning tune will sound every 5 seconds until user acknowledgement.

The Pump will continue infusing fluid into patient with a “Keep Vein Open” rate of 5ml/h. The KVO rate of 5ml/hr is also displayed in the Flow Rate LED.

Press **RUN/STOP** key to acknowledge the infusion complete message. The pump will be paused and the KVO infusion will be stopped.

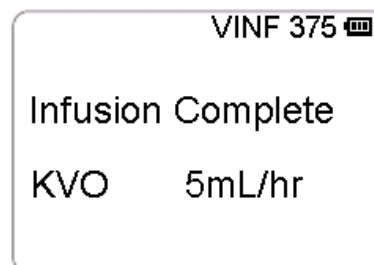

 **WARNING: Some Z-800 IV sets configurations do NOT have set based free-flow protection. Make sure to close roller clamp before removing administration set from Z-800 pump.**

GETTING STARTED

10-STEP MODE INFUSION

Access 10-STEP Mode Infusion

User may choose the 10 STEP infusion mode from CONFIGURATION screen after entering a new infusion

1. Turn on the pump and select **NEW INFUSION**.
2. Use Up/Down Arrow keys to highlight **10 STEP MODE** and press the Select soft-key.
3. The pump will display the Programming screen of the 10 STEP mode infusion.

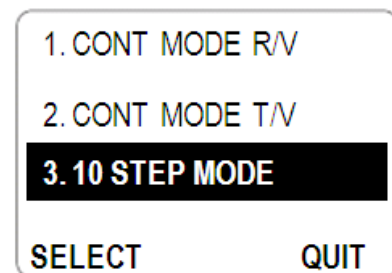
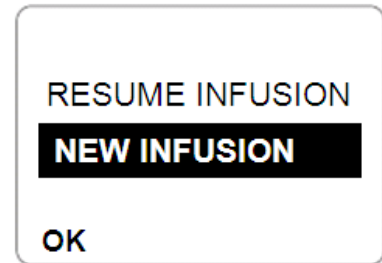

10-STEP MODE INFUSION (Continued)

Programming 10-STEP Mode Infusion

Similar to the Continuous Mode infusion programming screen, the 10-STEP infusion programming screen contains the following display areas:

1. **Status Bar:** The Status Bar displays current operating mode; current pump state; and volume infused.
 - **STEP 1:** 10-STEP mode operation.
 - **SET:** Pump programming state.
 - **VINF:** Volume Infused for the current infusion.
2. **Infusion Parameters:** Step 1 Flow Rate and Step 1 Volume To Be Infused.
 - **RATE:** Current Step Flow Rate.
 - **VTBI:** Current Step VTBI.
3. **Soft Keys:** Allow user to access pump configuration and Option setup screen.
 - **CONFIG:** Access pump configuration.
 - **OPTION:** Access 10-STEP infusion options.
 - **Up/Down Arrows:** Select parameter items and navigate between current step and previous/next step parameter programming.

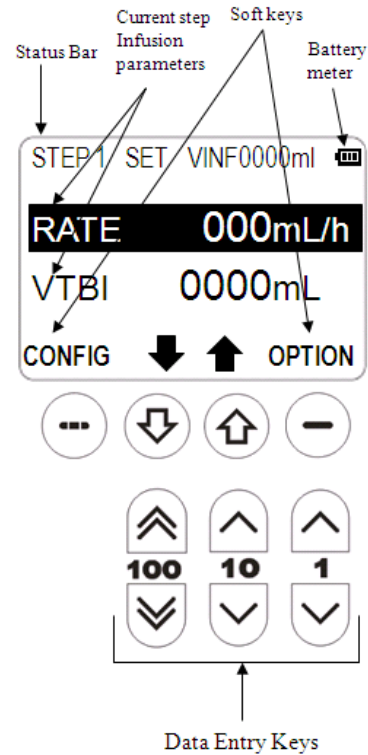

Navigate to Previous/Next Step

Use Up/Down Arrow keys to select current step parameters as well as change to previous or next step programming screen.

Similar to the Continuous Mode infusion programming screen, the 10-STEP infusion parameters may be programmed by using the UP/DOWN Arrow keys and Data Entry keys. Simply continue to scroll down to program each step. The ten steps are a scrollable list that can be edited anytime during programming. Scroll and carefully review the steps you programmed before pressing **RUN/STOP** to begin the infusion. Pressing **RUN/STOP** to begin the infusion locks in the list. To edit the list after an infusion is underway, press **RUN/STOP** to pause, and then press the **PROG** soft key to edit the list.

⚠ WARNING: Do not over-program VTBI. Program the actual amount of the fluid in the IV bag.

TPN MODE INFUSION

Access TPN Mode Infusion

User may choose the TPN auto ramp infusion mode from CONFIGURATION screen after entering a new infusion

4. Turn on the pump and select NEW INFUSION.
5. Use Up/Down Arrow keys to highlight **4. TPN MODE** and press the Select soft-key.
6. The pump will display the Programming screen of the TPN infusion.

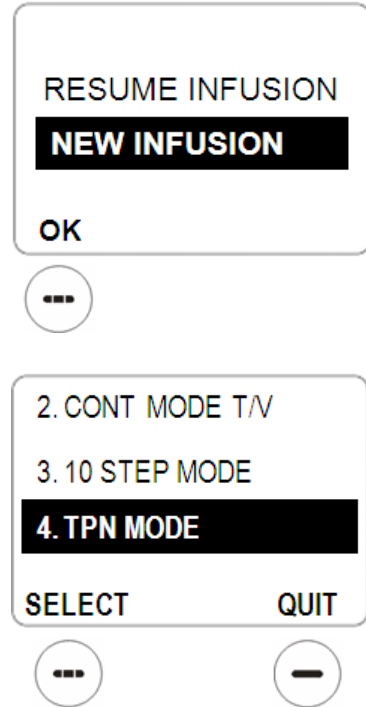

TPN MODE INFUSION (Continued)

Programming TPN Mode Infusion

TPN infusion programming screen contains the following display areas:

1. **Status Bar:** The Status Bar displays current operating mode; current pump state; and volume infused.
 - **TPN:** TPN mode operation.
 - **SET:** Pump programming state.
 - **VINF:** Volume Infused for the current infusion.
2. **Infusion Parameters:** TPN total VTBI and Total TIME of the infusion.
 - **TIME:** Total TIME of the infusion.
 - **VTBI:** Total Volume To Be Infused.
3. **Soft Keys:** Allow user to access pump configuration and TPN ramp programming screen.
 - **CONFIG:** Access pump configuration.
 - **RAMP:** Access TPN Ramp Up and Ramp Down Time parameter programming.
 - **Up/Down Arrows:** Highlight the selected parameter item.

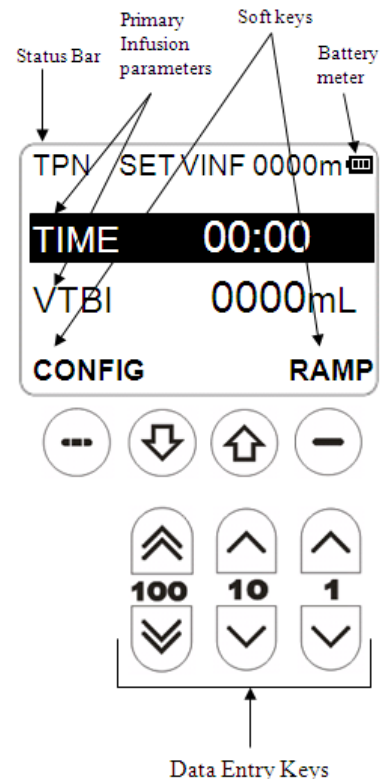

The TPN infusion parameters may be programmed by using the UP/DOWN Arrow keys and Data Entry keys.

Access TPN Ramp Time Parameter Programming

From TPN programming screen, press RAMP Soft-Key to access TPN Ramp Parameter programming screen.

Programming TPN Ramp Time Parameters

The TPN Ramp Time parameters may be programmed by using the UP/DOWN Arrow keys and Data Entry keys.

⚠ WARNING: Do not over-program VTBI. Program the actual amount of the fluid in the IV bag.

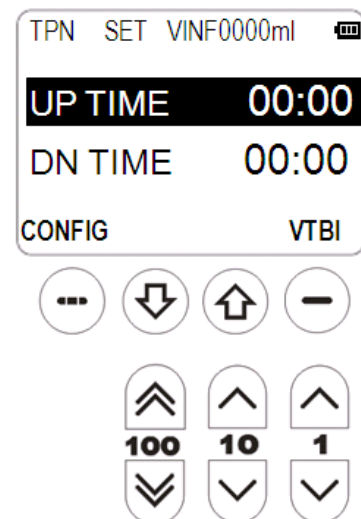

INTERMITTENT MODE INFUSION

Access Intermittent Mode Infusion

User may choose the Intermittent Mode from CONFIGURATION screen after entering a new infusion

1. Turn on the pump and select NEW INFUSION.
2. Use Up/Down Arrow keys to highlight **5. INTERMITTENT** and press the Select soft-key.
3. The pump will confirm that current application is “INTERMITTENT” and display the Programming screen of the intermittent mode infusion.
4. In the intermittent mode, pump runs for the period programmed, then idles before next period run. The sum of the “run” and the “idle” time is the cycle time, as illustrated below.

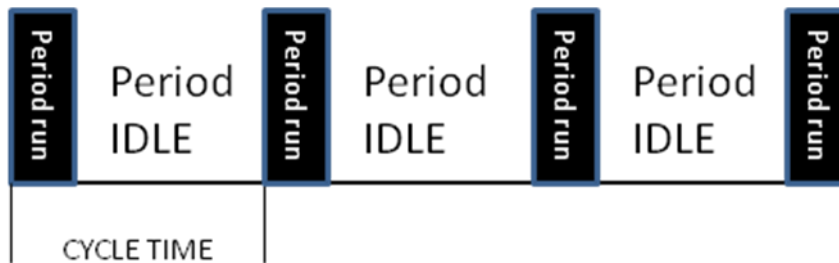
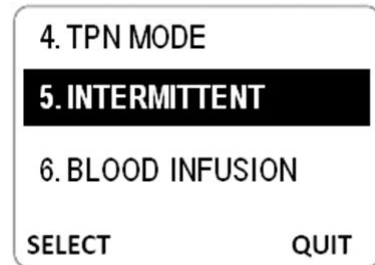
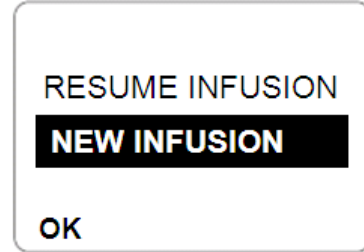

GETTING STARTED

INTERMITTENT MODE INFUSION (Continued)

Programming INTERMITTENT Mode Infusion

INTERMITTENT infusion programming screen contains the following display areas:

5. **Status Bar:** The Status Bar displays current operating mode; current pump state; and volume infused.
 - **INTR:** INTERMITTENT mode operation.
 - **PROG:** Pump programming state.
 - **VINF:** Volume Infused for the current infusion.
6. **Infusion Parameters:** INTERMITTENT total VTBI and Cycle TIME of the infusion.
 - **Total VTBI:** Total Volume To Be Infused.
 - **Cycle Time:** Time for each cycle (Hour : Minute format. Cycle time should be programmed between 30 minutes and 24 hours. If programmed Cycle Time is outside the range, pump alarms “Invalid Parameters”).
7. **Soft Keys:** Allow user to access pump configuration and INTERMITTENT ramp programming screen.
 - **CONFIG:** Access pump configuration.
 - **PERIOD:** Access INTERMITTENT period parameter programming.
 - **Up/Down Arrows:** Highlight the selected parameter item.

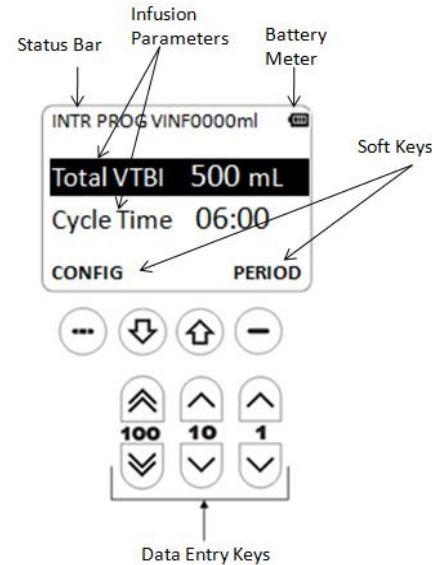

The Total VTBI and Cycle Time parameters may be programmed by using the UP/DOWN Arrow keys and Data Entry keys.

Note: During idle period, pump runs at KVO rate. Volume infused during idle period is counted. Pump alarms “Infusion Completed” once VINF (volume infused) equals programmed Total VTBI.

INTERMITTENT MODE INFUSION (Continued)

Programming INTERMITTENT Mode PERIOD parameters

INTERMITTENT infusion PERIOD programming screen contains the following display areas:

8. **Status Bar:** The Status Bar displays current operating mode; current pump state; and volume infused.
 - **INTR:** INTERMITTENT mode operation.
 - **PROG:** Pump programming state.
 - **VINF:** Volume Infused for the current infusion.
9. **Infusion Parameters:** INTERMITTENT Period VTBI and Period TIME of the infusion.
 - **Period VTBI:** Period Volume To Be Infused. The programmed value of this parameter has to be equal or less than the Total VTBI.
 - **Period Time:** Time for each period run (Hour : Minute format. Period time has to be programmed between 10 minutes and 23 hours. If programmed Period Time is outside the range, pump alarms “Invalid Parameters”).
10. **Soft Keys:** Allow user to access pump configuration and INTERMITTENT TOTAL programming screen.
 - **CONFIG:** Access pump configuration.
 - **TOTAL:** Access INTERMITTENT Total parameter programming.
 - **Up/Down Arrows:** Highlight the selected parameter item.

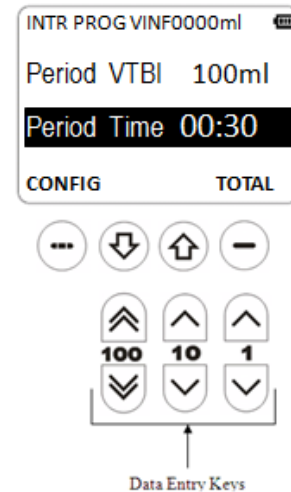

The Period VTBI and Period Time parameters may be programmed by using the UP/DOWN Arrow keys and Data Entry keys.

Example: To infuse total of 200mL drug intermittently, infuse 50mL(Period VTBI) every 6 hours (Cycle Time). The run time for each period is 10 minutes (Period Time), idle time in each cycle is 5 hours 50 minutes. The parameters can be programmed as follows:

Total VTBI: 200mL
Cycle Time: 06:00

Period VTBI: 50mL
Period Time: 10 minutes

BLOOD INFUSION

Access BLOOD INFUSION mode

User may choose the BLOOD INFUSION Mode from CONFIGURATION screen after entering a new infusion

1. Turn on the pump and select NEW INFUSION.
2. Use Up/Down Arrow keys to highlight **6. BLOOD INFUSION** and press the Select soft-key.
3. The pump will confirm that current application is “BLOOD INFUSION” and display the Programming screen of the BLOOD INFUSION mode.

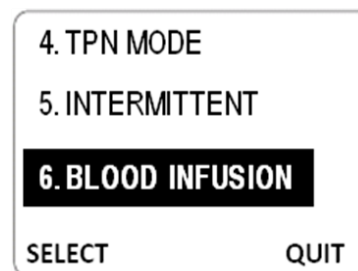
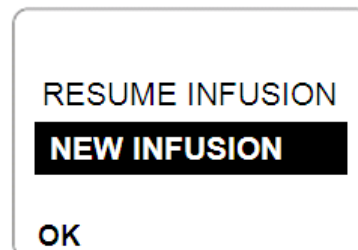

BLOOD INFUSION (Continued)

Programming Blood Infusion Mode parameters

Blood infusion programming screen contains the following display areas:

4. **Status Bar:** The Status Bar displays current operating mode; current pump state; and volume infused.
 - **BLD:** INTERMITTENT mode operation.
 - **PRG:** Pump programming state.
 - **VINF:** Volume Infused for the current infusion.
5. **Infusion Parameters:** INTERMITTENT Period VTBI and Period TIME of the infusion.
 - **RATE:** Blood flow rate.
 - **VTBI:** Volume To Be Infused.
6. **Soft Keys:** Allow user to access pump configuration programming screen.
 - **CONFIG:** Access pump configuration.
 - **Up/Down Arrows:** Highlight the selected parameter item.

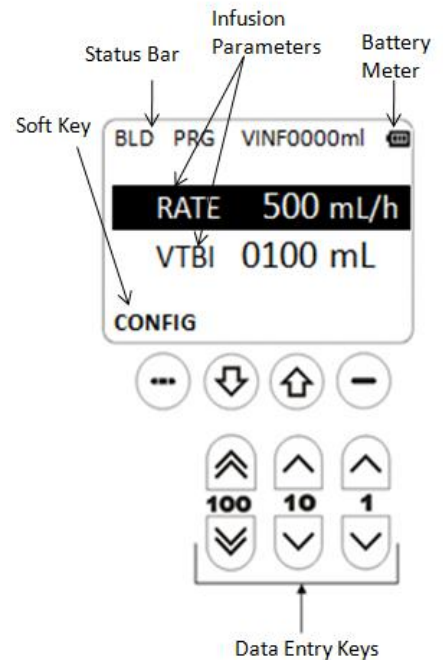

The RATE and VTBI parameters may be programmed by using the UP/DOWN Arrow keys and Data Entry keys.



GETTING STARTED

PRIME THE ADMINISTRATION SET USING PRIME KEY

User can use the **PRIME** key to prime an air bubbles out of the administration set from the distal end after it is loaded in the pump.

1. Press the **PRIME** key. The pump screen will display the PRIME warning message “Disconnect patient. Press PRIME or PURGE”. Confirm that the patient is not connected to the administration set. Press and hold the  key to prime.
2. During the prime, the pump will run at the fixed prime flow rate of 600mL/hr. Both Air-In-Line sensor and Occlusion sensor are disabled.
3. Release the  key when the set is fully primed. While the  key is pressed, the pump screen will report the volume primed. The maximum prime volume is 10mL. Upon reaching the maximum prime volume, the prime will stop.

 **WARNING: Patient must be disconnected before utilizing the PRIME key.**

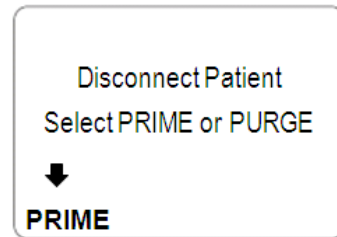

KEYPAD LOCKOUT

1. At the Infusion Programming screen, enter the infusion parameters.
2. Press the CLR soft key and immediately after that the 10's DOWN data entry key. An audio prompt tune will sound and a "PANEL LOCKED" message will be displayed for 3 seconds.

⚠ Keypad Lockout is done at Infusion Programming screen after user finish entering the infusion parameters but BEFORE pressing the RUN/STOP key.

3. During KEYPAD LOCKOUT, user may:
 - Press RUN/STOP key to stop and restart infusion.
 - Press PRIME key to prime the IV set.
 - Press ON/OFF key while the infusion is stopped to power off the pump.

4. Any other key press will result a message display of "PANEL LOCKED" for 3 seconds.

5. To unlock the keypad, press the CLR soft key and immediately after that the 10's DOWN data entry key at the Infusion Programming screen. An audio prompt tune will sound and a "PANEL UNLOCKED" message will be displayed for 3 seconds.

⚠ Keypad Unlock is done at Infusion Programming screen. User CANNOT lock/unlock keypad while pump is running an infusion.

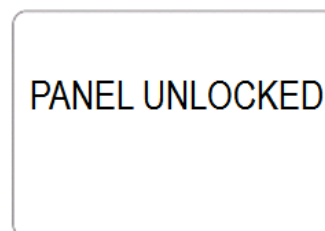
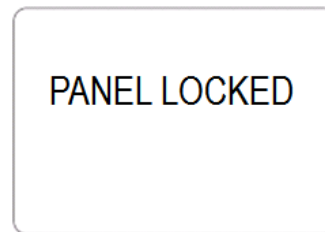

CLEAR VOLUME INFUSED

1. From primary or secondary setup state, user may elect to clear current volume infused (VINF) parameter.
2. Press **CLR** key, an audio prompt tune will sound and a “Clear VINF?” message screen will be displayed.
 - Press **OK** soft key to confirm the action
 - Press **QUIT** soft key to abort the action.
3. Upon user confirmation, the current VINF parameter will be reset to 0 ml.

NOTE: The VINF field will record cumulative infusion volume infused unless cleared by pressing the **CLR** soft key.



GETTING STARTED

POWERING OFF

Stop the Z-800 pump by pressing the **RUN/STOP** key during an infusion.

Press and hold down the **ON/OFF** key for 2 seconds. The pump will be put on standby state.



NOTE: Pump cannot be powered off during an infusion. User has to stop the infusion before pump can be turned off.

CHANGING PRIMARY SOLUTION CONTAINER

1. Stop the Z-800 pump by pressing the **RUN/STOP** key during an infusion.
2. Close roller clamp.
3. Remove empty solution container.
4. Spike new container.
5. Enter primary infusion programming screen.
Highlight Pri VTBI parameter. Use data entry keys to enter desired VTBI.
6. Open roller clamp.
7. Press RUN/STOP key to resume infusion.

 **WARNING: Some Z-800 IV sets configurations do NOT have set based free-flow protection. Make sure to close roller clamp before removing administration set from Z-800 pump.**

CHANGING AND RELOADING IV SET DURING INFUSION

Stop the Z-800 pump by pressing the **RUN/STOP** key during an infusion.

Close roller clamp.

Disconnect administration set from the patient.

Open pump door.

Remove administration set from the pump.

Prime and load a new administration set, as described in Prepare Infusion section.

Close pump door.

Open roller clamp.

Press RUN/STOP key to resume infusion.

 **WARNING: Some Z-800 IV sets configurations do NOT have set based free-flow protection. Make sure to close roller clamp before removing administration set from Z-800 pump.**

PROTOCOL MODE INFUSION

Access Protocol Mode Infusion

User may choose to save the current infusion parameters into the pump as a pre-defined protocol. The saved protocol can be retrieved in the future to automatically program a current infusion. This can eliminate repetitive programming for selected commonly used infusion regimens.

The Protocol infusion mode may be accessed from CONFIGURATION screen after entering a new infusion

1. Turn on the pump and select NEW INFUSION.
2. Use Up/Down Arrow keys to highlight **7. PROTOCOLS** and press the Select soft-key.
3. The pump will display the protocol names saved on the pump. There are up to 3 protocols can be saved on the pump.
4. Inside the protocol sub menu, choose one of the protocols by highlighting the name of the protocol. Press the SELECT soft key to select the highlighted protocol.
5. The pump will display the Programming screen of the pre-defined infusion mode with pre-defined infusion parameters populated.

Start Infusion

Verify displayed infusion parameter entries (Primary Rate, Primary VTBI, Secondary Rate, and Secondary VTBI). If a clamp is engaged, remove the clamp. Press **RUN/STOP** key to start the infusion.

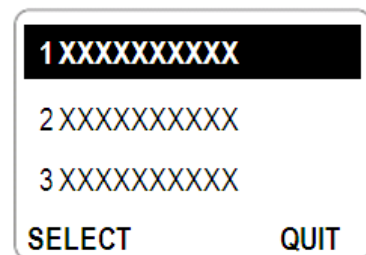
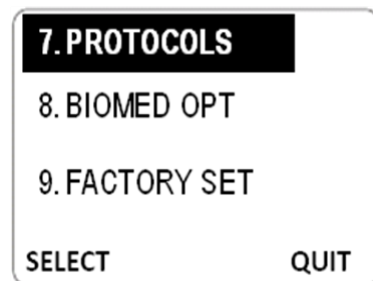
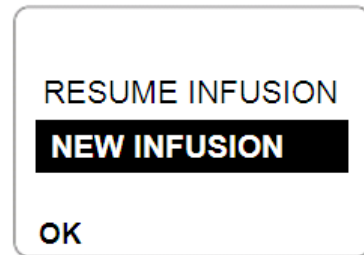

RUN/STOP key



GETTING STARTED

SAVE INFUSION PARAMETERS AS PROTOCOL

Turn on the pump; Select NEW INFUSION; Program an infusion.

Example:

1. Select **10 STEP Mode**. Program a 10 Step infusion with the following parameters.
 - **STEP 1:** RATE=50ml/h, VTBI=25ml.
 - **STEP 2:** RATE=100ml/h, VTBI=50ml.
 - **STEP 3:** RATE=150ml/h, VTBI=75ml.
 - **STEP 4:** RATE=200ml/h, VTBI=100ml.
 - **STEP 5:** RATE=250ml/h, VTBI=250ml.
2. From the 10 STEP Programming screen, press **CONFIG** soft key to access CONFIG screen. Select **8. BIOMED OPT**,
3. Inside BIOMED OPT sub menu, select **8.6. SAVE AS PROTOCOL**.
4. Select one of the 3 protocols to be used to store the infusion parameters. Enter in the name to be used for the protocol.
 - Use 10X numeric data entry key to scroll through letter A through Z.
 - Use 1X numeric data entry key to scroll through digit 0 through 9 and SPACE.
 - Use Up/Down Arrow to move cursor back and forth.
5. Press **SAVE** soft key to associate the current programmed infusion parameters with the protocol name as entered.

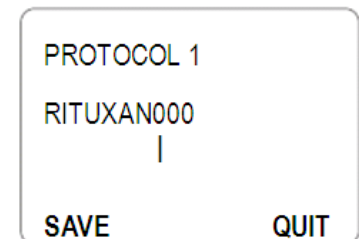
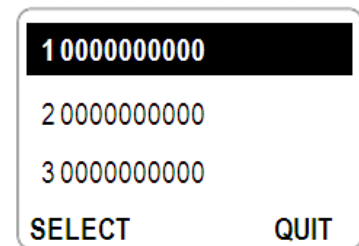
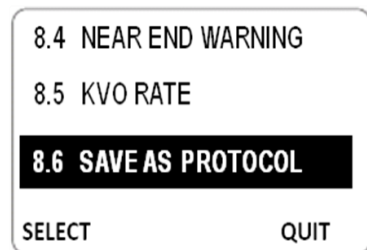
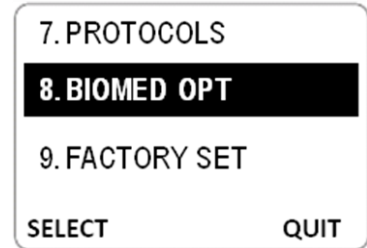

ALARMS AND TROUBLESHOOTING

To enhance safety and ease of operation, the Z-800 Pump provides a full range of audio and visual alarms, warnings, and prompts.

DEFINITIONS

- Error** An audio and visual signal that a failure has been detected. Immediate action is required.
- The affected Z-800 pump needs to be replaced with an operational unit. The affected pump should be serviced by qualified personnel.
- Alarm** An audio and visual signal indicates that a potentially unsafe condition is detected. Immediate action is required.
- Under an alarm condition, the Z-800 pump is in STOP state. The audio signal will sound until positive confirmation from user is delivered.
- Z-800 pump will not allow user to resume the infusion until the potentially unsafe condition is resolved.
- Warning** An audio and visual signal that a potentially unsafe condition is present. Immediate action is required.
- Under a warning condition, the Z-800 pump will continue to operate; the audio signal will not be silenced until the warning condition is resolved.

ALARMS AND TROUBLESHOOTING

ALARMS

Alarm	Meaning	Response
Air-in-line	Air has been detected in set during an infusion. Infusion stopped.	<ol style="list-style-type: none"> 1. Acknowledge the alarm by pressing RUN/STOP key. 2. The infusion is paused. 3. Clear air from line and press RUN/STOP key again to resume infusion.
Door Open	Pump door opened during an infusion. Infusion stopped.	<ol style="list-style-type: none"> 1. Acknowledge the alarm by pressing RUN/STOP key. 2. The infusion is paused. 3. Close pump door. Press RUN/STOP key again to resume infusion.
Occlusion	Increased back pressure sensed while infusing. Infusion stopped.	<ol style="list-style-type: none"> 1. Resolve the cause of the occlusion. 2. The infusion will resume when pressure reduced to below the alarm threshold.
No Drip	The drip sensor does not detect fluid drop in the drip chamber (Continues for 8mL, then alarms).	<ol style="list-style-type: none"> 1. Acknowledge the alarm by pressing RUN/STOP key. 2. The infusion is paused. 3. Verify that fluid container is not empty. Press RUN/STOP key again to resume infusion.
Battery Empty	Z-800 pump is operating on battery power and battery is too low for pump operation.	<ol style="list-style-type: none"> 1. Plug the power cord into an AC power outlet. 2. Acknowledge the alarm by pressing RUN/STOP key. 3. The infusion is paused. 4. Press RUN/STOP key again to resume infusion.

ALARMS AND TROUBLESHOOTING

WARNINGS

Warning	Meaning	Response
Low Battery	<p>Z-800 pump is operating on battery power and low battery condition is detected. Battery has 30 minutes or less of power at current rates before operation will stop.</p> <p>The infusion continues.</p> <p>The audio and visual warning message will appear every 5 seconds.</p>	<p>Plug the power cord into an AC power outlet. Audio warning will be silenced when AC power is detected.</p>
Pump Unattended	<p>Z-800 Pump detects the current infusion is paused and there is no user input for more than 5 minutes.</p> <p>The audio and visual warning message will appear every 5 seconds until infusion completion.</p>	<p>Press RUN/STOP key</p> <p>Z-800 Pump will display the current infusion programming screen.</p>
Near End	<p>Z-800 Pump detects the current infusion is about to end in 3 minutes.</p> <p>The audio and visual warning message will appear every 5 seconds until infusion completion.</p>	<p>Prepare for completion of the infusion which will occur in 3 minutes.</p>
Infusion Complete – KVO	<p>Infusion completed The pump automatically switches over to KVO mode.</p> <p>The visual warning message will appear and audio alarm will sound constantly until user acknowledgement.</p>	<p>Press RUN/STOP key</p> <p>Z-800 Pump will be paused.</p>

ALARMS AND TROUBLESHOOTING

ERRORS

Error	Meaning	Response
System Error	System has detected an error on the pump. Infusion stops.	Press RUN/STOP key to silence alarm and to stop using the affected pump. The pump must be taken out of service until serviced by qualified service personnel.

SPECIFICATIONS

Pumping Mechanism:	Linear Peristaltic
Flow Rate:	1 - 999 ml/h in 1 ml increments
Priming Rate:	900 ml/h
Volume to be Infused:	1 - 9,999 ml in 1 ml increments
Accuracy:	± 5 %
Time Memory is maintained:	Permanent for previous infusion parameters.
Air-in-Line Detector:	Ultrasonic. 14 level configurable
Occlusion Detector:	Pressure sensor. 14 level configurable
Electrical Standard:	Class I, Type BF
Electrical Safety	Complies with: EN 60601-1 (Medical Electrical Equipment Safety), IEC 60601-2-24 (Infusion pumps and controllers), IEC 60601-1-4 (Programmable Electrical Medical System), UL 2601- 1 and CAN/CSA C22.2 No 601.1.
Power Requirements:	110 – 240 VAC, 50-60 Hz
Power Consumption:	25 VA (at maximum flow rate)
Internal Battery:	Rechargeable Nickel-Metal-Hydride 9.6V; 1.8 Amp-hr (4.5 Amp-hr Option) (Replaceable by qualified service personnel only)
Battery Life at 125 ml/h:	4 hours (Extended Battery Option 8 hours)
Battery Charging:	Automatic when pump plugged into an AC power source
Pump Housing:	Cast Aluminum & Sheet Metal
Weight:	2.6 kilograms, 5.7 lbs
Dimensions:	8.6”H x 5.7”W x 5.3”D
Standards:	Manufactured in accordance to ISO 9001:2000 and ISO 13485:2003.

SPECIFICATIONS (Continued)

Environmental Specifications: **Non Operating Conditions** (Transportation and Storage):
Temperature: -40°C to 55 °C (-13 °F to + 122 °F)
Humidity: < 93% R.H., non-condensing
Air pressure: 48kPa to 110kPa

Operating Conditions

The system may not meet all performance specifications if operated outside of the following conditions:

Temperature: +10°C to +40 °C (+59 °F to + 113 °F)
Humidity: 30 % to 75% R.H. at +40 °C, non-condensing
Air pressure: 700hPa to 1060hPa

IV Administration Set: Use only Zyno Medical approved IV sets.

Alarms: Air-in-Line;
Occlusion;
Door Open;
Battery Empty
No Drip (Optional)



Warnings: Low Battery;
Pump Unattended;
Near End;
Infusion Complete – KVO

Errors: System Error

CONFIGURABLE SETTINGS

Adjusting the Occlusion Pressure Threshold

Pressure Sensor detects down-stream occlusion in the IV sets. User may specify occlusion alarm pressure threshold in configuration screen. The occlusion alarm threshold can be adjusted between 4 psi and 30 psi

1. From the configuration menu, Select **8. BIOMED OPT.**
2. In the BIOMED OPTION menu, Select **8.1. PRESSURE.**
3. In the Pressure sub-menu, use **Up/Down Arrow** to adjust the occlusion alarm pressure threshold.
4. Press **OK** soft key  to confirm the set value.
Press **QUIT** soft key  to back out of PRESSURE sub menu. Press **QUIT** soft key  again to exit the BIOMED OPTION menu

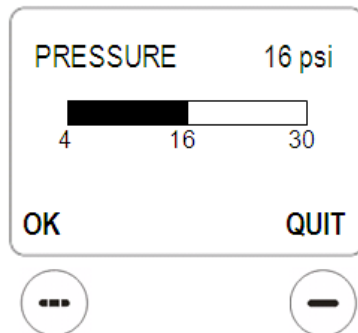
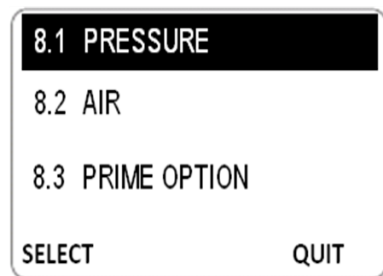
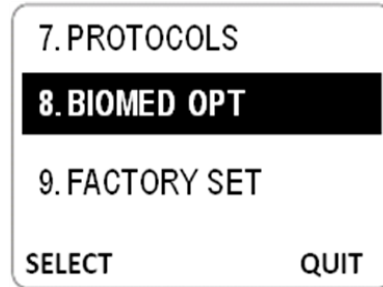





 **WARNING:** The factory default settings should be used unless qualified clinical personnel determine that other customized settings are appropriate and safe.

CONFIGURABLE SETTINGS (Continued)

Adjusting the Air-In-Line Alarm Threshold

The Z-800's Air-In-Line sensor detects an air bubble in the administration set tubing. Air-In-Line alarm threshold can be adjusted in the **BIOMED OPTION** configuration menu. Alarm threshold can be adjusted to air bubble size from a volume of 2 micro-liters to 280 micro-liters. The Z-800's Air-In-Line Detector alarm threshold can be adjusted by the user.

1. From the configuration menu, Select **8. BIOMED OPT**.
2. In the BIOMED OPTION menu, Select **8.2. AIR**.
3. In the AIR sub-menu, use **Up/Down Arrow**   to adjust the air-in-line alarm threshold.
4. Press **OK** soft key  to confirm the set value.
Press **QUIT** soft key  to back out of AIR sub menu. Press **QUIT** soft key  again to exit the BIOMED OPTION menu

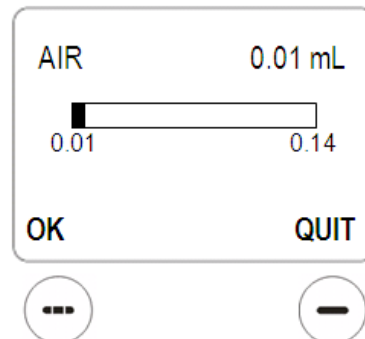
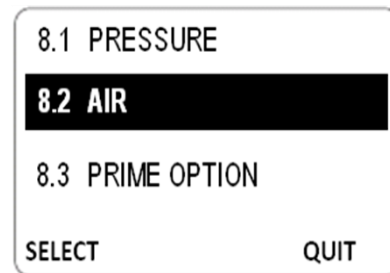
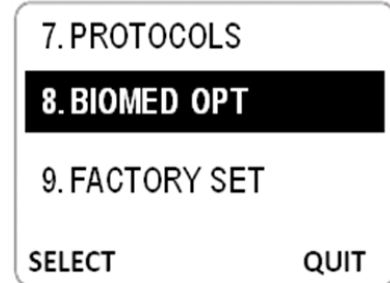





 **WARNING:** The factory default settings should be used unless qualified clinical personnel determine that other customized settings are appropriate and safe.

CONFIGURABLE SETTINGS (Continued)

Enable/Disable Drip Sensor Option

The Z-800 pump has an optional external drip sensor, which may be used to detect a fluid container empty event. The user may enable or disable the drip sensor in the **BIOMED OPTION** configuration menu. When enabled, the drip sensor will detect the absence of drips in the drip chamber, continue to infuse 8mL, then alarm and stop the pump.

1. From the configuration menu, Select **8. BIOMED OPT**.
2. In the BIOMED OPTION menu, Select **8.7. DRIP SENSOR**.
3. In the DRIP SENSOR sub-menu, use **Up/Down Arrow**   to select ENABLE or DISABLE the drip sensor.
4. Press **SELECT** soft key  to confirm the set value. Press **QUIT** soft key  to back out of DRIP SENSOR sub menu. Press **QUIT** soft key  again to exit the BIOMED OPTION menu

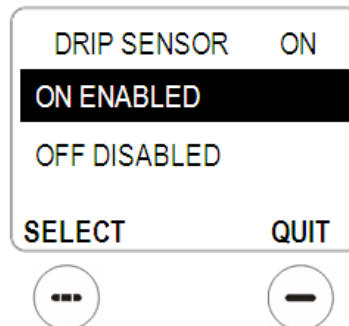
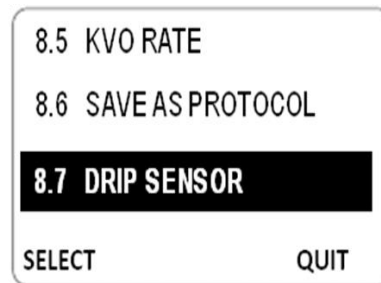
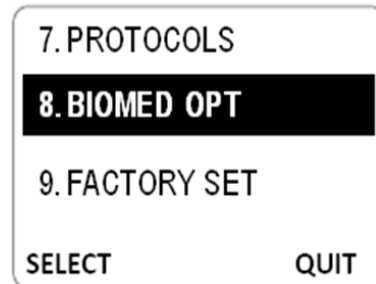





CONFIGURABLE SETTINGS (Continued)

Adjusting the Alarm Volume

The Z-800 pump is able to generate multiple audio alert tunes to indicate pump alarm, warning, error or prompt.

Audio alarm volume may be adjusted by the user.

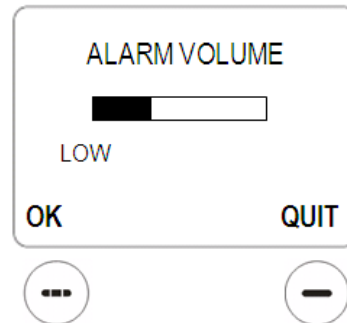
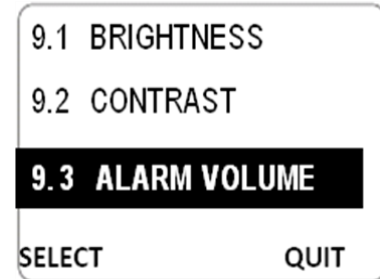
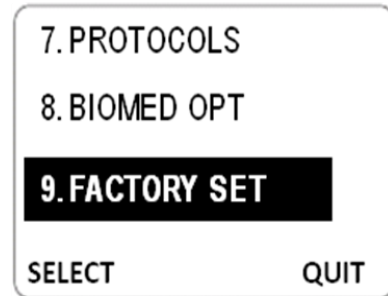

1. From the configuration menu, Select **9. FACTORY SET**.
2. In the FACTORY SETTING menu, Select **9.3. ALARM VOLUME**.
3. In the ALARM VOLUME sub-menu, use **Up/Down Arrow**   to adjust alarm volume to LOW, MID or HIGH.
4. Press **OK** soft key  to confirm the set value.
Press **QUIT** soft key  to back out of ALARM VOLUME sub menu. Press **QUIT** soft key  again to exit the FACTORY SETTING menu





CONFIGURABLE SETTINGS (Continued)

Adjusting the LCD Brightness

The Z-800 Main LCD Display's brightness level can be adjusted by the user.

1. From the configuration menu, Select **9. FACTORY SET**.
2. In the FACTORY SETTING menu, Select **9.1. BRIGHTNESS**.
3. In the BRIGHTNESS sub-menu, use **Up/Down Arrow**   to adjust LCD brightness within range of 1 to 10.

Press **OK** soft key  to confirm the set value. Press **QUIT** soft key  to back out of BRIGHTNESS sub menu. Press **QUIT** soft key  again to exit the FACTORY SETTING menu

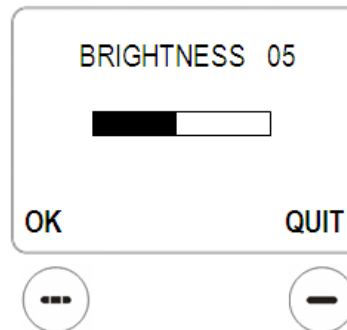
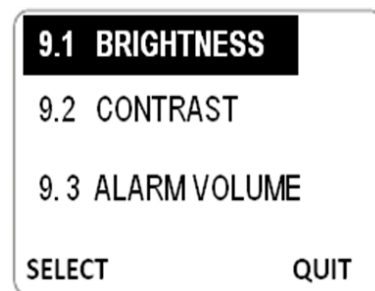
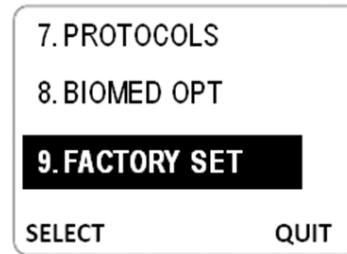

STORAGE

Store the pump away from excessive heat, cold, or humidity.



Keep the pump plugged into an AC outlet during storage, to ensure a fully charged battery when needed.

 (AC indicator light) will be on whenever the Z-800 Pump is plugged in.

BATTERY CARE AND MAINTENANCE

Battery Type and Charging

The Z-800 can operate on internal rechargeable battery power, enabling continued infusion when the patient is being transferred or during electrical power failure.

When the pump runs on battery power, the POWER indicator  is off, and BATTERY indicator  is on.

The Z-800 Pump is equipped with a standard configuration of 9.6 volt 1800mAh Nickel-Metal-Hydride battery, or a extended battery option of 9.6 volt 4500mAh Nickel-Metal-Hydride battery. The battery is charging whenever the pump is plugged into an AC receptacle. The life expectancy of the battery is dependent on the amount of use, the depth of discharge, and the state of the charge that is maintained. Generally, the battery will have the longest life (recommended replacement = 1-2 years) if the pump is always plugged in and the battery use is infrequent. Frequent use of battery power and insufficient battery charge cycles will significantly decrease the life of the battery.

The quality of the battery is also a significant factor in determining battery life and runtime. The battery cannot be repaired and should not be opened. The battery may only be replaced with an approved battery from Zyno Medical. Use of any other brand may yield poor performance, and will invalidate the warranty.

The battery should be charged in a room with a temperature between 50 – 80.6 °F (10 – 27 °C), to minimize charge time and maximize battery life.

BATTERY CARE AND MAINTENANCE (Continued)

Battery Operating Time

Battery run time is a function of the activity of the device. In the standard battery configuration of a 1800mAh battery, a fully charged new battery will provide approximately 4 hours of operation infusing at 125ml/h. The extended battery option of 4500mAh will provide approximately 8 hours of operation infusing at 125ml/h. As flow rate increases, the power consumption increases, the battery operating time will decrease accordingly. See TABLE. Battery Operating Time on the right. In the standard configuration, a fully discharged battery will return to a fully charged capacity in 14-18 hours in an ambient temperature between 50 – 80.6 °F (10 – 27 °C). The extended battery configuration option is accompanied with a fast charging circuitry, which will complete the full charge in 5-6hrs.

Table: Battery Operating Time

Flow Rate	1800mAh Battery	4500mAh Battery
1ml/hr	5 hrs	10hrs
25ml/hr	5 hrs	10hrs
125ml/hr	4 hrs	8hrs
999ml/hr	3 hrs	6hrs

Battery Cycle Life and Aging

As batteries get older and go through many charge/discharge cycles, batteries “wear out”, in that the chemicals and materials used to construct the cell break down. It is estimated that there will be a 30% capacity decrease of battery capacity over a 200 full discharge/charge cycles within 2 years of normal use. As battery ages, the battery operating time will decrease.

 **CAUTION:** The battery capacity indicator display represents the total capacity of the battery measured by voltage. It only represents the percentage of battery capacity against its total capacity. As battery ages, the total capacity of the battery will decrease.

Partial Discharge/Recharge

When a battery is partially discharged, then charged for less than the full time, differences between individual cell capacities result in cells completing charge at different times. If the full charge sequence is not then completed, the cell “mismatch” becomes progressively greater. This will be observed by user as low apparent run times and premature low battery warning and alarms. The lowered capacity is not permanent, but may require 2-3 full discharge/charge cycles to recover.

BATTERY CARE AND MAINTENANCE (Continued)

Battery Care

The battery capacity should be checked at least once every 12 months.

If the Z-800 pump is to be stored at temperatures in excess of 86 °F (30 °C) for one or more months, the battery should be removed and placed in an environment between 50 – 86 °F (10-30 °C).

If the battery is to be stored for more than one year, they should be charged at least once per year to prevent leakage and deterioration in performance due to self-discharge.

When the battery is first being put into use, or has been out of use for one or more months, it will not have full capacity due to deactivation of reactants. Restore such battery to original performance by repeating one or two cycles of fully charging and fully discharging.

Some temporary reduction in capacity might become apparent if the battery is repeatedly discharged less than completely. One or two cycles of full discharge and full charge can restore full performance.

The Z-800 Pump is shipped with a battery in a discharged condition. Connect the power cord to an AC receptacle and allow the battery to charge for 18 hours.

Whenever possible, leave the power cord connected to an external AC power source while operating.

 **CAUTION:** Battery replacement should be performed by qualified service personnel while the instrument is not in use.

 **CAUTION:** All pump configuration settings need to be verified and reset as needed after a complete discharge of battery.

 **CAUTION:** DO NOT open, incinerate or short circuit battery. Worn out batteries must be disposed properly, according to local regulations.

CLEANING

DO NOT spray cleaning fluids directly onto the instrument or immerse the instrument in fluids.

DO NOT use solutions containing phosphoric acid (Foamy Q&A*), aromatic solvents (naphtha, paint thinner, etc.), chlorinated solvents* (Trichloroethane, MEK, Toluene, etc.), ammonia, acetone, benzene, xylene or alcohol, other than as specified below.

DO NOT use hard or pointed objects to clean any part of the instrument.

Acceptable cleaning solutions are:

Warm water

Mild detergent (e.g., Manu-Klenz®)

** 10% bleach solution (1 part bleach to 9 parts water)

** Compublend™ II

** Envirocide®

** 2% Glutaraldehyde in water

** Hydrogen Peroxide 3%

** 70% Isopropyl Alcohol

** 2% Phenols in water (O-Syl 1:128, Pheno-Cen 1:256, Vesphene®)

** 10% Providone Iodine (betadine™)

** Quaternaries 1:512

WEX-CIDE

1. Keep the instrument upright and do not allow any part of the instrument to become saturated with or submerged in fluid during the cleaning operation.
2. Use soft cloth dampened with warm water and a mild nonabrasive cleaning solution to clean all exposed surfaces. Do not spray any fluids directly on the instrument. For sanitizing or antibacterial treatment, use 10% bleach solution and water.

 **WARNING:** Turn the instrument off and unplug the power cord from the AC power source before cleaning.

Do not spray fluid directly onto the instrument.

Do not steam autoclave, EtO sterilize, immerse the instrument or allow fluid to enter the instrument case.

Failure to follow these instructions may result in an electrical hazard, damage to the instrument, and voided warranty coverage.

 **CAUTION:** The solutions/solvents identified as NOT to be used can damage the surface of the instrument.

** After application, rinse all surfaces with a water-dampened soft cloth.

INSPECTION REQUIREMENTS

To ensure the system remains in good operating condition, both regular and periodic inspections are required.

REGULAR INSPECTIONS:

Regular inspection consists of a visual inspection for damage and cleanliness, and performing the procedure described in the Start-Up Sequence section of this instruction for use before each usage of the instrument. Regular inspections are not covered under the contract or agreement offered by Zyno Medical and must be performed by the user.

 **WARNING:** Failure to perform these inspections and maintenance may result in improper instrument operation.

REGULAR INSPECTIONS

<u>PROCEDURE</u>	<u>FREQUENCY</u>
<u>INSPECTION FOR DAMAGE:</u>	
Enclosure	Each usage
Power Cord	Each usage
<u>CLEANING</u>	<u>As Required</u>
<u>START-UP SEQUENCE</u>	<u>Each usage</u>

NOTE: If the instrument does not pass the regular inspection, the affected instrument must be removed from use and inspected by qualified service personnel

PERIODIC MAINTENANCE:

Periodic maintenance of the hardware is required at least once per year. A service agreement may be obtained from Zyno Medical for the performance of all required periodic maintenance.

NOTE: Periodic maintenance should only be performed by qualified service personnel.

SERVICE INFORMATION

If a Z-800 Pump fails to respond as described in this Instruction for Use and the cause cannot be determined, do not use the affected instrument. Contact qualified service personnel.

Within the United States, application and service information may be obtained by writing to Zyno Medical LLC. at:

Zyno Medical LLC.
9 Tech Circle
Natick, MA, 01760
ATTN: Instrument Service

Within the United States, information or assistance may be obtained by calling the Zyno distributor who provided the pump, or by calling Zyno Medical at (781)-895-1980.

Outside of United States, service information, applications, and manuals may be obtained by contacting your local Z-800 Infusion Pump distributor.

When submitting any request for service, include:

- A description of the difficulty experienced.
- Z-800 Pump serial number.
- Instrument settings and solution(s) used.
- Description, model and lot number(s) of the administration sets in use.
- Message displayed at the time of difficulty.

If it is necessary to return the instrument for service, obtain a return authorization number prior to shipment. Carefully package the instrument (preferably in the original packaging), reference the return authorization information, and return it to the appropriate service or distribution center. Zyno Medical does not assume any responsibility for loss of, or damage to, returned instruments while in transit.

Product complaints or adverse incidents should be reported to the Zyno Medical Quality Assurance Department at the above address. With each complaint, please include the pump serial number and a full description of the difficulty encountered, including all settings, types of fluids, times, and alarm messages. Return the administration set used if possible. Contact the Zyno Medical Customer Service Department for an RMA number prior to return.

WARRANTY

Zyno Medical LLC. (hereinafter referred to as “Zyno Medical”) warrants that:

- A. Each new Zyno Medical Z-800 infusion pump is free from defects in material and workmanship under normal use and service for a period of one (1) year from the date of delivery by Zyno Medical to the original purchaser.
- B. Each new accessory (including batteries) is free from defects in material and workmanship under normal use and service for a period of ninety (90) days from the date of delivery by Zyno Medical to the original purchaser.

If any product requires service during the applicable warranty period, the purchaser should communicate directly with their relevant account representative to determine the appropriate repair facility. Except as provided otherwise in this warranty, repair or replacement will be carried out at Zyno Medical’s expense. The product requiring service should be returned promptly, properly packaged and postage prepaid by purchaser. Loss or damage in return shipment to the repair facility shall be at purchaser’s risk.

In no event shall Zyno Medical be liable for any incidental, indirect or consequential damages in connection with the purchase or use of any Zyno Medical product. This warranty shall apply solely to the original purchaser. This warranty shall not apply to any subsequent owner or holder of the product. Furthermore, this warranty shall not apply to, and Zyno Medical shall not be responsible for, any loss or damage arising in connection with the purchase or use of any Zyno Medical product which has been:

- (a) repaired by anyone other than an authorized Zyno Medical service representative;
- (b) altered in any way so as to affect, in Zyno Medical’s judgement, the product’s stability or reliability;
- (c) subjected to misuse or negligence or accident, or which has had the product’s serial or lot number altered, affected, or removed;
- (d) improperly maintained or used in any manner other than in accordance with the written instructions furnished by Zyno Medical.

This warranty is in lieu of all other warranties, express or implied, and of all other obligations or liabilities of Zyno Medical, and Zyno Medical does not give or grant, directly or indirectly, the authority to any representative or other person to assume on behalf of Zyno Medical any other liability in connection with the sale or use of Zyno Medical products.

Zyno Medical DISCLAIMS ALL OTHER WARRANTIES, EXPRESS OR IMPLIED, INCLUDING ANY WARRANTY OF MERCHANTABILITY OR OF FITNESS FOR A PARTICULAR PURCHASE OR APPLICATION.

ALARM TESTING PROCEDURE

Air-in-Line Alarm Test

1. Open the pump door and remove the administration set. Close the pump door.
2. Program primary flow RATE at 500 ml/h, and primary VTBI at 100 ml.
3. Press **RUN/STOP** key to start the infusion.
4. The infusion status indicator will turn blinking red, audio alarm will sound, and the Main Display will show "AIR-IN-LINE". The infusion will be stopped.
5. Press the **RUN/STOP** key again to acknowledge the alarm condition. Z-800 Pump will be in PAUSE state. "PAUSE" message will appear on the display screen.
6. Clear the Air-in-Line condition. Press **RUN/STOP** key again to resume infusion.

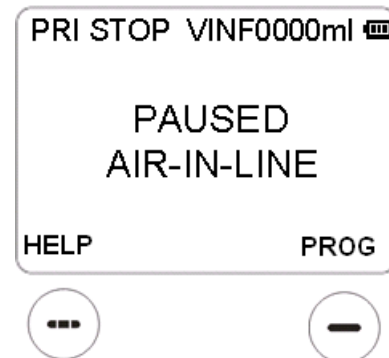
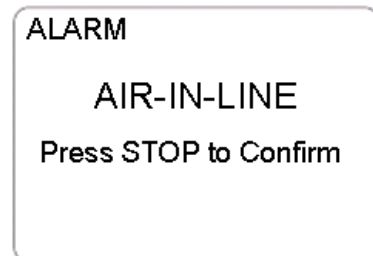

Door Open Alarm Test

1. Start a primary infusion. During operation, open the pump door.
2. The infusion status indicator will turn blinking red, the audio alarm will sound, and the Main Display will show "Door Open". The infusion will be stopped.
3. Press **RUN/STOP** key to acknowledge the alarm condition. Z-800 Pump will be in PAUSE state. "PAUSE" message will appear on the display screen.
4. Close pump door. Press **RUN/STOP** key again to resume infusion.

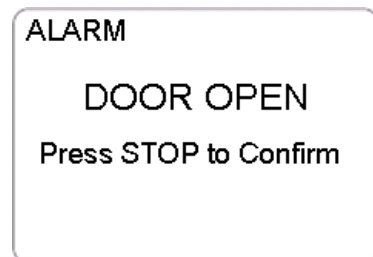

ALARM TESTING PROCEDURE (Continued)

Occlusion Alarm Test

1. Program a primary infusion rate for 200 ml/h and VTBI for 50ml.
2. Press **RUN/STOP** key to start the infusion.
3. Close the roller clamp on the administration set located directly at the distal side of the pump.
4. After a few seconds, the infusion status indicator will turn blinking red, audio alarm will sound, and the Main Display will show alarm screen with "Occlusion". The infusion will be stopped.
5. Press **RUN/STOP** key to acknowledge the alarm condition. Z-800 Pump will be in PAUSE state. "PAUSE" message will appear on the display screen.
6. Open the roller clamp to release pressure. Press **RUN/STOP** key again to resume infusion.

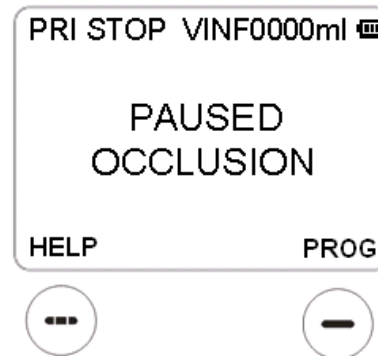
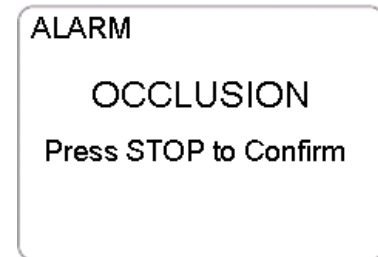

Time Delay to Occlusion

The maximum time for activation of the downstream occlusion alarm at the minimum flow rate of 1ml/hr is around 5 minutes at the minimum occlusion threshold setting. It is more than 1 hour at the maximum occlusion alarm threshold setting.

The maximum time for activation of the downstream occlusion alarm at the intermediate flow rate of 25ml/hr is around 20 seconds at the minimum occlusion threshold setting. It is around 3 minutes at the maximum occlusion alarm threshold setting.



Occlusion Bolus Volume

The maximum bolus volume generated as a result of operation at 25 ml/hr and reaching the minimum downstream occlusion alarm threshold is 0.25ml. The maximum bolus volume generated as a result of operation at 25 ml/hr and reaching the maximum downstream occlusion alarm threshold is 0.8mL.

Note: At slower infusion rates, the occlusion alarm may take longer to alarm.

ALARM TESTING PROCEDURE (Continued)

Battery Test

1. Connect the Z-800 pump to an approved AC power outlet for at least 18 hours to allow the battery to fully charge.
2. Unplug the power cord from the AC power. Turn on the device. Verify that the battery indicator  is ON
3. Set a primary infusion with the following:
 - Pri RATE = 125 ml/h
 - Pri VTBI = 1000ml/h
4. Start the infusion. Record the infusion starting time.
5. Record the time when the Low Battery Warning is presented.
6. Verify the following:
 - Pump continues to operate during Low Battery warning.
 - The Battery indicator  turned to red.
 - The warning audio tune and a visual message “Low Battery, Plug in AC power” is presented every 10 seconds.
7. Record the time when the Battery Empty alarm is presented. Record the current VINP, Pri RATE and Pri VTBI parameters. Verify that the following:
 - Battery Empty alarm continues to sound until user acknowledgement.
 - Infusion is stopped
8. Allow the Battery Empty Alarm to continue to sound.
9. Record the time the pump shut itself off.
10. Connect the device to an approved AC power outlet.
11. Turn on the device. Verify 12-14 below.

LOW BATTERY

Plug in AC Power
Immediately

BATTERY EMPTY

Press STOP to Confirm

ALARM TESTING PROCEDURE (Continued)

Battery Test (Continued)

12. All pump configuration parameters are preserved.
13. All current infusion parameters are preserved.
14. If any one of the following is true, contact a qualified service personal to replace the battery:
 - Time interval between the Low Battery Warning and Battery Empty Alarm is less then 15 minutes.
 - Time interval between the Battery Empty Alarm and the pump shut down is less than 2 minutes.
 - Pump configuration setting changed after battery depletion.
 - Any of the current infusion parameters is not preserved.

APPROVED ADMINISTRATION SETS

WARNING:

Use only administration sets labeled as Zyno Medical with the Z-800 Infusion Pump System. The use of any other set for use with Z-800 system may cause improper instrument operation, resulting in inaccurate fluid delivery or other potential hazards.

The following lists some of the most commonly used administration sets approved for use with the Z-800 Infusion Pump System. New administration sets configurations are added frequently. For complete administration set configurations, please visit Zyno Medical's web site at www.zynomed.com.

CAUTION:

The recommended minimum set exchange time for the Zyno Administration set is 72 hours.

Primary Needle-less Injection Port Sets	
PART #	ADMINISTRATION SET DESCRIPTION
A2-80071-P	105" Administration set with 1 back check valve and 1 Needle-less Access Port on the proximal side; universal spike drip chamber (20 drops/ml); roller clamp, male luer lock; non-DEHP tubing; Latex-free; Approximate priming volume 16 ml
A2-80071-D	105" Administration set with 1 Needle-less Access Port on the distal side; universal spike drip chamber (20 drops/ml); roller clamp, male luer lock; non-DEHP tubing; Latex-free; Approximate priming volume 16 ml
A2-80072	105" Administration set with 1 proximal Needle-less Access Port; 1 distal Needle-less Access Port; back check valve; universal spike drip chamber (20 drops/ml); roller clamp, male luer lock; non-DEHP tubing; Latex-free; Approximate priming volume 16 ml
A2-80070	105" Administration set with universal spike drip chamber (20 drops/ml); roller clamp, male luer lock; non-DEHP tubing; Latex-free; Approximate priming volume 16 ml

Secondary Sets	
PART #	ADMINISTRATION SET DESCRIPTION
A2-80075	40" Administration set with universal spike drip chamber (20 drops/ml); roller clamp, male luer lock; non-DEHP tubing; Approximate priming volume 8 ml

APPROVED ADMINISTRATION SETS (Continued)

Primary Sets with Anti-Free-Flow Valve	
PART #	ADMINISTRATION SET DESCRIPTION
A2-83071-D	105” Administration set with 1 Needle-less Access Port on the distal side; universal spike drip chamber (20 drops/ml); roller clamp, male luer lock; non-DEHP tubing; Latex-free; Anti-Free-Flow Valve; Approximate priming volume 16 ml
A2-83071-P	105” Administration set with 1 back check valve and 1 Needle-less Access Port on the proximal side; universal spike drip chamber (20 drops/ml); roller clamp, male luer lock; non-DEHP tubing; Latex-free; Anti-Free-Flow Valve; Approximate priming volume 16 ml
A2-83072	105” Administration set with 1 proximal Needle-less Access Port; 1 distal Needle-less Access Port; back check valve; universal spike drip chamber (20 drops/ml); roller clamp, male luer lock; non-DEHP tubing; Latex-free; Anti-Free-Flow Valve; Approximate priming volume 16 ml
A2-83070	105” Administration set with universal spike drip chamber (20 drops/ml); roller clamp, male luer lock; non-DEHP tubing; Latex-free; Anti-Free-Flow Valve; Approximate priming volume 16 ml

Primary Filter Sets	
PART #	ADMINISTRATION SET DESCRIPTION
A2-80071-DF	105” Administration set with 1 Needle-less Access Port on the distal side; universal spike drip chamber (20 drops/ml); roller clamp, male luer lock; non-DEHP tubing; Latex-free; 0.22 micron IV Express® filter; Approximate priming volume 16 ml
A2-80072-F	105” Administration set with 1 proximal Needle-less Access Port; 1 distal Needle-less Access Port; back check valve; universal spike drip chamber (20 drops/ml); roller clamp, male luer lock; non-DEHP tubing; Latex-free; 0.22 micron IV Express® filter; Approximate priming volume 16 ml
A2-80070-F	105” Administration set with universal spike drip chamber (20 drops/ml); roller clamp, male luer lock; non-DEHP tubing; Latex-free; 0.22 micron IV Express® filter; Approximate priming volume 16 ml
A2-83071-DF	105” Administration set with 1 Needle-less Access Port on the distal side; universal spike drip chamber (20 drops/ml); roller clamp, male luer lock; non-DEHP tubing; Latex-free; 0.22 micron IV Express® filter; Anti-Free-Flow Valve; Approximate priming volume 16 ml
A2-83072-F	105” Administration set with 1 proximal Needle-less Access Port; 1 distal Needle-less Access Port; back check valve; universal spike drip chamber (20 drops/ml); roller clamp, male luer lock; non-DEHP tubing; Latex-free; 0.22 micron IV Express® filter; Anti-Free-Flow Valve; Approximate priming volume 16 ml

Blood Sets	
PART #	ADMINISTRATION SET DESCRIPTION
A2-81071-D	104" Administration set with 1 Needle-less Access Port on the distal side; 2 spikes; drip chamber with 180 micron blood filter; roller clamp, male luer lock; non-DEHP tubing; Latex-free; Approximate priming volume 30 ml



Zyno Medical LLC.
 9 Tech Circle
 Natick, MA, 01760
 USA

Phone: 1-508-650-2008
 Fax: 1-508-650-2006